

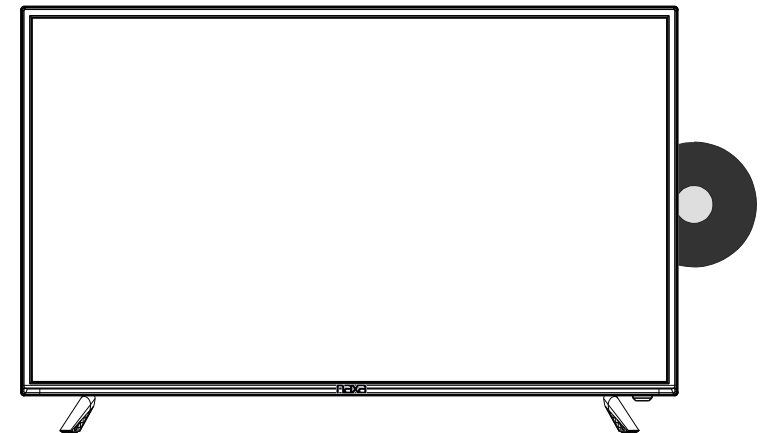

**39.5 CLASS WIDE SCREEN FHD LED
TV WITH DVD PLAYER**

MODEL NO.: NTD-4050



Instruction Manual

PLEASE READ CAREFULLY BEFORE USE

USER'S MANUAL

FCC Notice

This device complies with Part 15 of the FCC Rules. Operation is subject to the following two conditions: (1) this device may not cause harmful interference, and (2) this device must accept any interference received, including interference that may cause undesired operation.

Warning: Changes or modifications to this unit not expressly approved by the party responsible for compliance could void the user's authority to operate the equipment.

NOTE: This equipment has been tested and found to comply with the limits for a Class B digital device, pursuant to Part 15 of the FCC Rules. These limits are designed to provide reasonable protection against harmful interference in a residential installation. This equipment generates, uses and can radiate radio frequency energy and, if not installed and used in accordance with the instructions, may cause harmful interference to radio communications.

However, there is no guarantee that interference will not occur in a particular installation. If this equipment does cause harmful interference to radio or television reception, which can be determined by turning the equipment off and on, the user is encouraged to try to correct the interference by one or more of the following measures:

- Reorient or relocate the receiving antenna.
- Increase the separation between the equipment and receiver.
- Connect the equipment into an outlet on a circuit different from that to which the receiver is connected.
- Consult the dealer or an experienced radio/TV technician for help.

Support

If you have problems with your device, please consult the instructions in this manual. Please also visit us on the web at www.naxa.com to get up to the minute news, alerts, and documentation for your device. For additional assistance, please contact Naxa Technical support.

NAXA Technical Support
2320 East 49th St.
Vernon, CA 90058
Tel: (323)-583-8883
http://www.naxa.com/naxa_support/
Made in China

Safety Information

Warning

To prevent fire and/or electric shock, do not use this plug with an extension cord, receptacle or other outlet unless the blades can be fully inserted to prevent blade exposure. Do not expose this appliance to rain or moisture.



Important Safety Instructions

Read these instructions.
Keep these instructions.
Heed all warnings.
Follow all instructions.
Please, unplug the TV power cord when the following conditions occur:
-When there is a thunderstorm (Please, unplug the power cord and antenna).
-When cleaning the TV set.
-When the TV set is not used for a long time.
Do not use corrosive solvents when cleaning the TV set.
Do not put the TV set in direct sunlight or near heat.
Do not put a heat source, such as a candle or heater, on top of or near the TV set.
Leave plenty of space (at least 10cm) around the TV set for ventilation.
Place the TV set away from where it can become wet (such as near a window).
Do not put a container with liquid (such as a vase) on top of the TV set.
Do not move the TV set when the power is on.
Do not touch, push, or scratch the surface of the TV set with hard materials or items. When TV surfaces are dirty, please use a wet cotton cloth or soft cloth with non-corrosive cleaners to clean it carefully. Do not use acetone, toluene or alcohol to clean the TV set. Avoid excess moisture, which can damage inner electronic components. If too much moisture is present, the TV screen may appear blurry or spotty. It is recommended that a technician install the TV set on a wall, if such placement is desired.
An incorrect wall installation will be unsafe and hazardous.
Do not let children climb on or play around the TV set to avoid falls, collisions, damage, and/or injuries.
Do not hit the TV panel with hard objects.
Do not cover the TV set with blankets or other objects when it is connected to a power source, which may cause overheating and fire.
Batteries shall not be exposed to excessive heat such as direct sunlight, fire or the like. The power plug is used to disconnect the device. The disconnected device will not operate while unplugged.
Apparatus with class I construction shall be connected to a electrical outlet with a protective grounding connection.

Important Safety Precautions

Safety

Immediately pull out the AC power plug if there is an abnormal sound or smell or the LED TV has sound but no picture, and contact customer support.



The LED TV should be kept free from any moisture and dust to prevent electrical shock and short circuits. Do not cover the ventilation openings with blankets, tablecloths, curtains, etc. While plugged in.

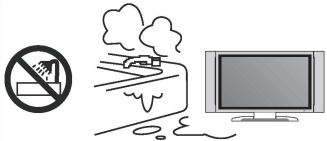

Keep the LED TV away from any heat sources or direct sunlight. To ensure good ventilation, allow 10 cm. between the LED TV and other appliances or built-in cabinet walls.

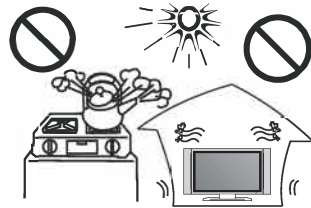

When you wipe the front cabinet, please make sure the power plug is pulled out and use a soft, dry, lint-free cloth and handle it with care. Do not repeatedly wipe the panel, nor scrape, tap or strike the panel with a hard object.

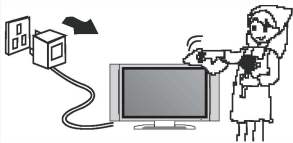

Do not wipe the LED TV with any petrol, chemical or alcohol based solvents as it will lead to product damage of the panel and cabinet.

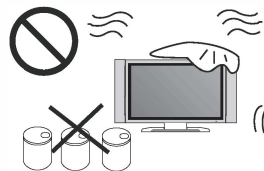

Important Safety Precautions

Safety

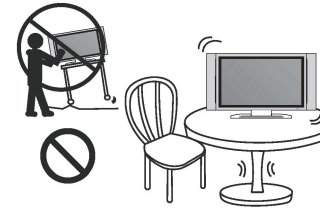

Do not place the LED TV on an unstable surface.

To avoid tripping or damage to the power cord, do not place the power cord or cables across a walkway. Do not overload the electrical outlet or extension cable. The power plug should easily plug and unplug from the electrical socket. Do not force the plug into/out of the socket.

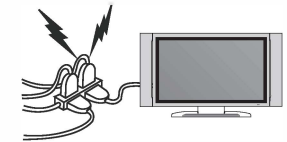

Do not disassemble the back cover, as it contains high voltages inside and will cause electric shock. Only qualified professionals should conduct internal adjustments, maintenance, and checks.

Do not expose the TV set to water, vapor, or moisture of any kind. Objects filled with liquid shall not be placed on or near the device. Do not place the LED TV near an open flame, such as lit candles. If there is moisture in the TV, immediately unplug the TV and contact customer support.

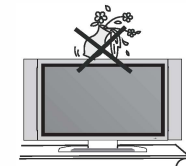

Unplug the power cord and antenna cable during electrical storms to prevent damage to the LED TV from electrical surges. Keep clear of the antenna cable during electrical storms.

Table of Contents

Introduction	
Features	2
Specifications	3
Accessories	4
General Description	4-9
Overview of front and side panel	4
Overview of back panel	5
Overview of remote control	6-8
Installing Batteries in the remote control	9
Antenna connection	9
External Connection	10-16
Connecting VCR	10
Connecting DVD Player/Set-Top Box	11
Connecting Digital Audio System	12
Connecting USB	13
Connecting DVD Player/Set-Top Box via HDMI	14
Connecting PC	15
Connecting a Headphone	16
Supporting signals	16
Basic operation	17
Turning the TV On and Off	17
OSD Menu Operations	18-25
INPUT SOURCE SELECTION	18
BASIC OPERATION	18
FIRST TIME INSTALLATION	18
PICTURE	19
AUDIO	20
TIME	21
SETUP	21-22
LOCK	23
CHANNEL	24
PC SETTINGS	25
USB Operation	25-26
DVD Setup Menu	27
DVD Operation	28
Troubleshooting	29
Picture defects and the reason	30

Introduction

Features

- TV uses a TFT LED display screen
- FHDTV Compatible (480i, 480p, 720p, 1080i, 1080p)
- Supports American TV Standards 8VSB/Free 64/256QAM, NTSC System, ATSC System
- Connect directly to computer to achieve a TV/monitor.
- Zero X radiation complies with green environment protection requirement
- Advanced Chroma Processing
- Closed captioning/Program Control
- SAP/STEREO/MONO; ATSC.
- HDMI input
- USB input

Input terminals used for external equipment connection

Input terminals used for external equipment connection

One computer VGA/PC input	One PC Audio input
One AUDIO L/R input	Three HDMI input
One EARPHONE output	One USB input
One ANTENNA input	One Coaxial output
One Y(CVBS)/Pb/Pr input	One AUDIO L/R output

Introduction

Specifications

Display screen type	Color active matrix LED display
Model	NTD-4050
The maximum resolution	1920 × 1080
Image control	Fine digital control
Power supply	AC 100-240V~50/60Hz
TV reception	NTSC System, ATSC System
Frequency range	Antenna: 2~69; Cable: 2~125
Antenna input impedance	75Ω (Unbalance)
Sound output	2 * 8W
Power supply for remote controller	DC 3V (Two AAA size batteries)
Power consumption	80 W
Dimensions (LXWXH)	35.9 * 8.1 * 22.5 Inch
Weight (Net weight)	14.3 lbs
Operation environment temperature	0°C-40°C

Note:

Design and specification modification maybe made at any time without prior notice; all data and dimensions are approximations.

Accessories

Please make sure the following items are included with your LED TV. If any items are missing, contact your dealer.



Remote Control & Batteries (AAAx 2)

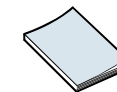

Owner's Instructions

General Description

Overview of front and side panel

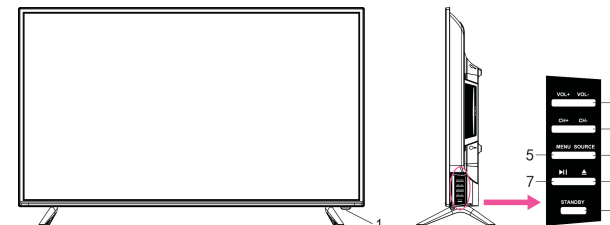

1. Remote control sensor / Power indicator
2. VOLUME +/-
Press to increase/decrease the volume.
3. CHANNEL +/-
Press to change channels.
4. SOURCE
Toggles between all the available input sources.
5. MENU
Press to see an on-screen menu of your TV.
6. ▲
Press this button when the power is on the disc will eject. Press it again the disc is pulled in automatically.
7. ||
After placed a disc in the disc tray, press this button to play the disc and press it again to pause.
8. STANDBY
Press STANDBY button to toggle between normal and standby mode.

General Description

Overview of back panel

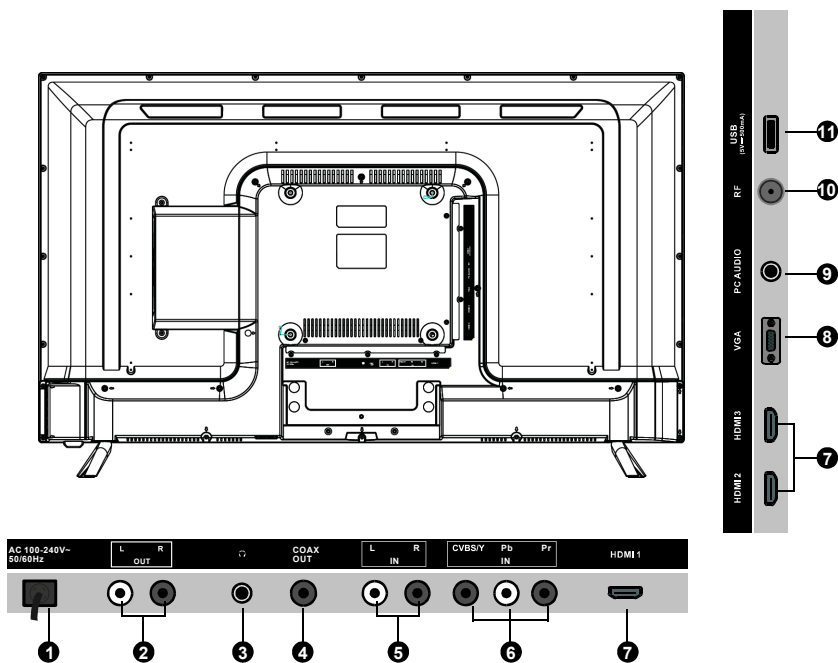

- | | |
|---|---|
| 1. Power input | 7. HDMI 1 & 2 & 3
Connect to the HDMI jack of a device with a HDMI output. |
| 2. L/R OUT
Audio output | 8. VGA/PC IN
Connect to the video output jack on your PC. |
| 3. EARPHONE
Connect a set of phone for private listening. | 9. PC AUDIO
Audio input for external devices. |
| 4. COAXIAL
Connect to a Digital Audio device. | 10. ANTENNA INPUT
Connect to an antenna or cable NTSC & ATSC. |
| 5. AUDIO L/R
Audio input for external devices, such as a camcorder or VCR. | 11. USB (TV)
USB input |
| 6. Y(CVBS)/ Pb / Pr
Connect video. | |

General Description

Overview of remote control

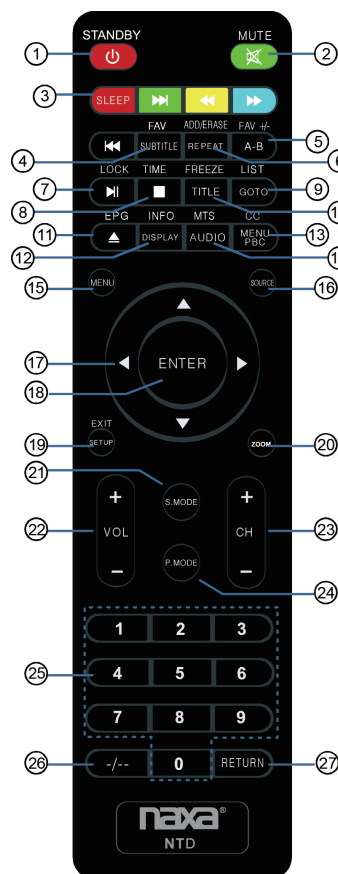

1. **STANDBY**: Turn the TV on/off.
2. **MUTE**: Press to mute the sound.
3. **SLEEP**: Set the sleep timer.
4. **FAV**: Select favorite channels.
5. **FAV +/-**: Press to watch next / previous favorite program.
6. **ADD**: Add this program to the favorite channels list.
- ERASE**: Delete this program from the favorite channels list.
7. **LOCK**: Press to display the Lock menu.
8. **Time**: Press to display current time.
9. **LIST**: Press to display the TV program list.
10. **FREEZE**: Press to freeze the screen.
11. **EPG**: Press to display the EPG menu.
12. **INFO**: Display channel information.
13. **CC**: Press to display the closed caption.
14. **MTS**: Press to select the audio channels.
15. **MENU**: TV system setup.
16. **SOURCE**: Press to change input source.
17. **ARROW buttons**: Use to move cursor up/down/left/right.
18. **ENTER**: Validation key.
19. **EXIT**: Press to exit menu.
20. **ZOOM**: Press to change the screen scale.
21. **S.MODE**: Press to cycle through the different sound settings.
22. **VOL +/-**: Press to increase/decrease the sound level.
23. **CH +/-**: Press to scan through channels.
24. **P.MODE**: Press repeatedly to cycle through the available video picture modes.
25. **Number key (0-9)**: Press 0-9 to select a TV channel directly when you are watching TV. The channel changes after several seconds multiple program channel such as 2-1, etc.
26. **-/--**: Press this button to enter a program number for multiple program channel such as 2-1, etc.
27. **RETURN**: Return to the previous channel viewed.

General Description

Overview of remote control

DVD Mode :

When in DVD mode, use the arrows in the bottom section of the remote to operate the menus etc.

EJECT BUTTON(▲)

Press the EJECT button when the power is on the disc will eject. Put the disc in the slot slightly, with the data side facing towards you. Press EJECT button again the disc is pulled in automatically, and the unit starts playing automatically (Without auto play function for JPEG discs).

MENU PBC BUTTON

Press menu button and the screen will display "Root Menu", select item according to your preference. (This button is valid to DVD disc possessing multilayer Menu). PBC button lets you play Video CDs, interactively. If PBC is on, you can use the number buttons to select tracks in the menu. If PBC is off, you can select the tracks directly.

AUDIO BUTTON

When play DVD, by pressing this button, you can change the audio language from the one selected at the initial settings to a different language, available.

REPEAT BUTTON(REP)

Press the REPEAT button one time, it repeats the chapter. Press it again and it repeats the Title. Press the third time and it repeats All. Press the fourth time and the repeat function cancel.

A-B REPEAT BUTTON(REPA-B)

Press the A-B button once to set point A Press the A-B button a second time to set point B. After setting the program repeat playing from A to B. Pressing the A-B button a third time will cancel the repeat.

TITLE BUTTON

Press TITLE button, there will have an screen indication "TITLE".

Press the direction or numeric buttons to select

your favourite title. Will play from the first chapter of the selected title.(for DVD disc only)

ENTER: Validation key. (bottom section of ENTER button for DVD function only)

ARROW BUTTONS (◀▶/▲▼):Use to move cursor up/down/left/right. (direction buttons of bottom section for DVD function only)

SUBTITLE: This function may enable you to select multi subtitle languages
Press the SUBTITLE button to get desired display.

DISPLAY: Press display button to show the the information of the DVD player.

GO TO BUTTON

Press this button to go to desired position . The player provides below search mode.

DVD T/T 00/07CH 002/003⊙ 00:01:30

[DVD]

CD TRK 01/15 ◀ HDCP⊗ ⊙ 00:01:30

[CD]

When the above items are showed on LED screen, you can input numbers to locate desired sector.

The number you input is invalid if it is beyond the track's capacity.

General Description

Overview of remote control

PLAY AND PAUSE BUTTON(▶/⏸)

Press this button to start playback. Press this button again to pause playback.

STOP BUTTON(■)

Press button once to stop. Press button to resume from where you stopped.

Press button Twice to stop. Press button to start from beginning. In order to protect the disc, press button then press EJECT button to take the disc out. When the disc is ejected, hold the disc edge to prevent scratches.

When not using the DVD function (in standby mode or using others modes for a long time), please take out the disc to protect the DVD loader and the disc.

PREV/NEXT BUTTON(◀◀/▶▶)

When playing a DVD disc, press PREV to play the previous chapter. when playing a VCD, CD disc, press PREV to play the previous track.

When playing a DVD disc, press NEXT to play, the next chapter. when playing a CD disc, press NEXT to PLAY the next track.

FR/FF BUTTON(◀/▶)

To Use Fast Forward or Fast Reverse:

1. When playing a DVD, press FF button to fast forward through the disc. Press FR button to fast reverse through the disc.
2. Press PLAY button to resume normal playback.

SETUP

Press this button to enter DVD setup menu page and then press navigation buttons to select and adjust selected item.

General Description

Installing Batteries in the Remote Control

Installing Batteries

- 1 Open the battery compartment cover on the back side.

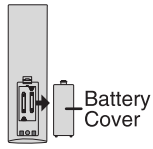

- 2 Insert two AAA batteries inside the battery compartment with their + and - ends aligned as indicated. Do not mix old and new batteries or different types of batteries.

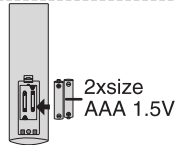

- 3 Close the cover.

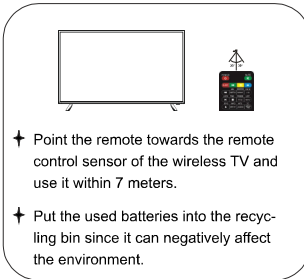
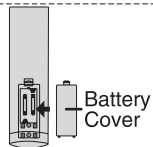

† Point the remote towards the remote control sensor of the wireless TV and use it within 7 meters.

† Put the used batteries into the recycling bin since it can negatively affect the environment.

Note:

- Batteries should last for 1 year under normal use.
- If you do not intend to use the remote control for a long period of time, remove the batteries to prevent damage due to leakage.
- Do not use old and new batteries together.
- The batteries or battery pack shall not be exposed to excessive heat such as direct sunlight, fire, or other heat sources.

External Connection

Antenna connection

Antenna input impedance of this unit is 75ohm. VHF/UHF 75ohm coaxial cable can be connected to the antenna jack directly, if the antenna cable is 300ohm parallel flat feeder cable, you need to use the 300ohm/75ohm converter to connect the antenna cable to the antenna jack. For details Please refer to the following drawing.

Antennas with 300ohm flat twins Leads

Antennas with 75ohm Round Leads

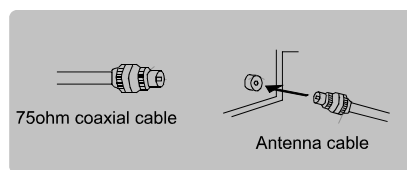
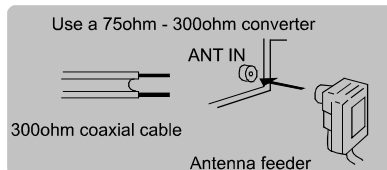

External Connection

Connecting VCR

These instructions assume that you have already connected your TV to an antenna or a cable TV system. Skip step 1 if you have not yet connected to an antenna or a cable system.

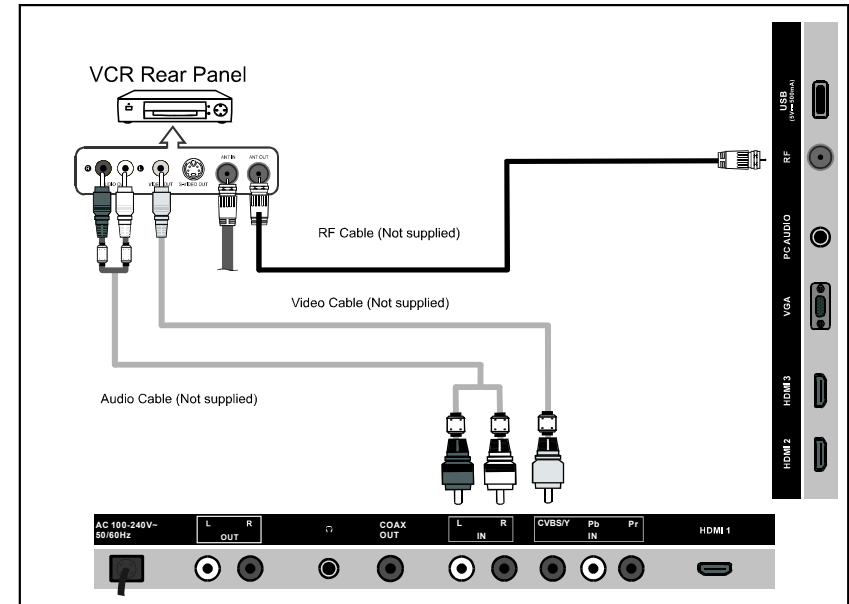

Follow the instructions in Viewing a VCR or Camcorder Tape to view your VCR tape. Each VCR has a different back panel configuration.

When connecting a VCR, match the color of the connection terminal to the cable. We recommend the use of cables with a Ferrite Core.

1. Unplug the cable or antenna from the back of the TV.
2. Connect the cable or antenna to the ANT IN terminal on the back of the VCR.
3. Connect an RF Cable between the ANT OUT terminal on the VCR and the ANT IN terminal on the TV.
4. Connect a Video Cable between the VIDEO OUT jack on the VCR and the VIDEO IN jack on the TV.
5. Connect Audio Cables between the AUDIO OUT jacks on the VCR and the AUDIO L and AUDIO R jacks on the TV.
 - If you have a mono (non-stereo) VCR, use a Y-connector (not supplied) to hook up to the right and left audio input jacks of the TV. If your VCR is stereo, you must connect two cables.

External Connection

Connecting DVD Player/Set-Top Box

The rear panel jacks on your TV make it easy to connect a DVD to your TV.

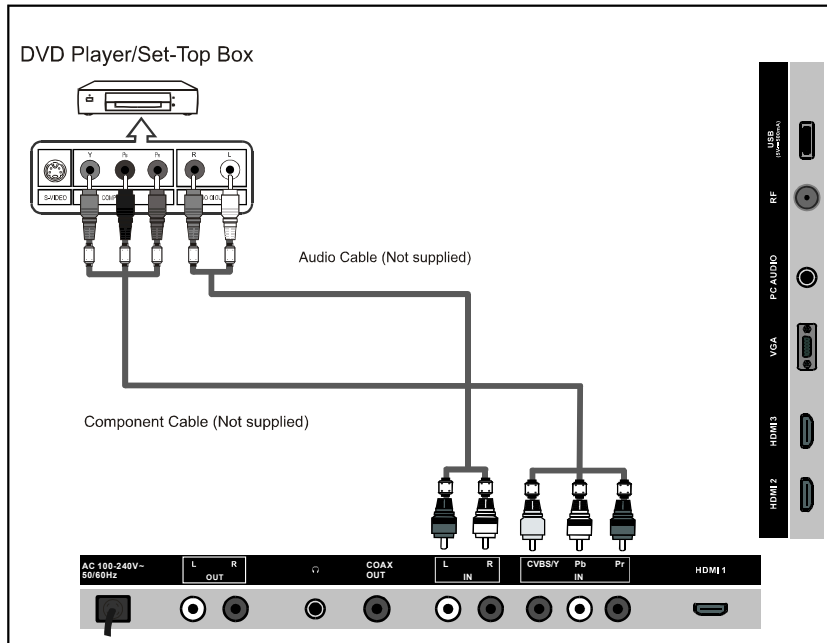

Component video separates the video into Y (Luminance (brightness)), Pb (Blue) and Pr (Red) for enhanced video quality.

Be sure to match the component video and audio connections.

For example, if connecting the video cable to COMPONENT IN, connect the audio cable to COMPONENT IN also.

Each DVD player/STB has a different back panel configuration.

When connecting a DVD player/STB, match the color of the connection terminal to the cable.

We recommend the use of cables with a Ferrite Core.

1. Connect a Component Cable between the COMPONENT IN [Y, PB, PR] jacks on the TV and the COMPONENT [Y, PB, PR] jacks on the DVD player.
2. Connect Audio Cables between the COMPONENT IN [R-AUDIO-L] jacks on the TV and the AUDIO OUT jacks on the DVD player.

External Connection

Connecting Digital Audio System

The rear panel jacks on your TV make it easy to connect a Digital Audio System to your TV.

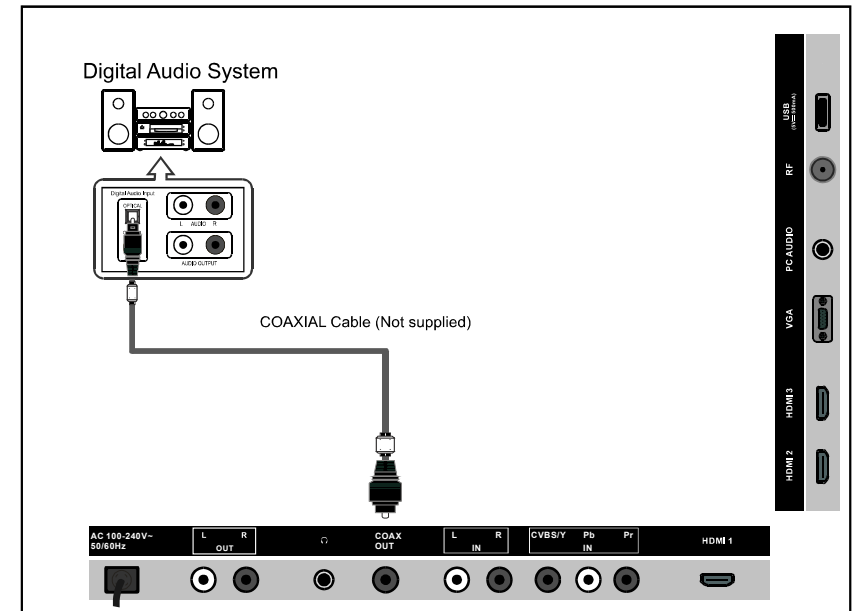

5.1 CH audio is possible when the TV is connected to an external device supporting 5.1 CH.

We recommend the use of cables with a Ferrite Core.

1. Connect a COAXIAL Cable between the SPDIF jacks on the TV and the Digital Audio System Input jacks on the Digital Audio System. When a Digital Audio System is connected to the SPDIF terminal: Decrease the gain (volume) of the TV, and adjust the volume level with the system's volume control.

External Connection

Connecting USB

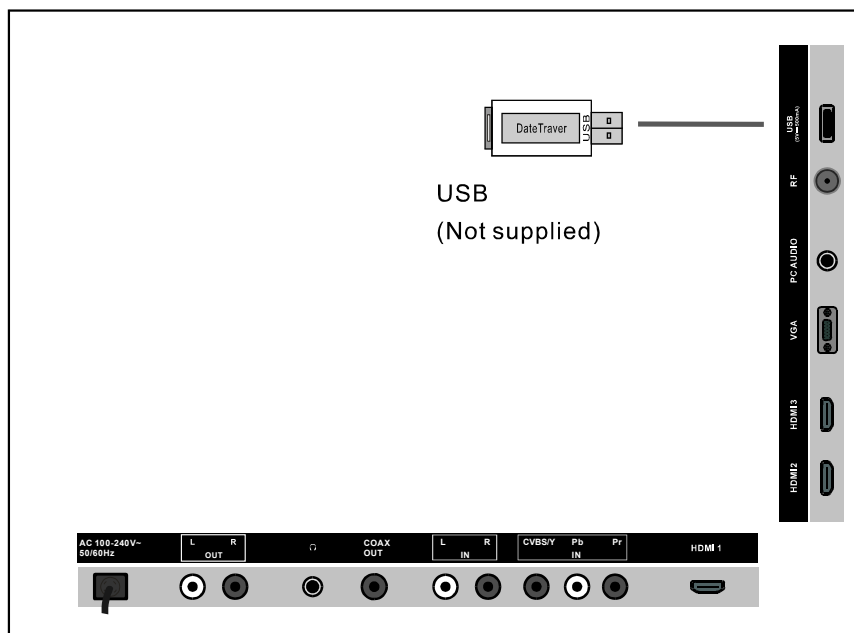

Connect a USB 2.0 memory device into USB slot of this TV for multimedia files playback.

1. This USB slot only supports Music (MP3) and Photo (JPG) multimedia files playback.
2. This TV is compatible with most USB devices in the market. However, we cannot guarantee the compatibility of all USB devices, due to multiple technology standards used.

External Connection

Connecting DVD Player/Set-Top Box via HDMI

This connection can only be made if there is a HDMI Output connector on the external device.

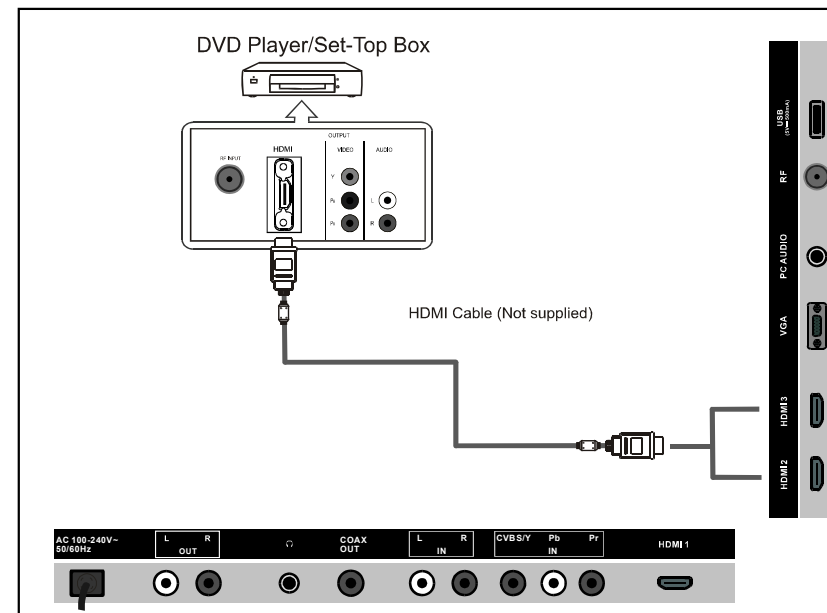

What is HDMI.

HDMI, or high-definition multimedia interface, is a next-generation interface that enables the transmission of digital audio and video signals using a single cable without compression.

Multimedia interface is a more accurate name for it especially because it allows multiple channels of digital audio (5.1 channels).

The difference between HDMI and DVI is that the HDMI device is smaller in size, has the HDCP(High Bandwidth Digital Copy Protection) coding feature installed, and supports multi-channel digital audio.

Each DVD player/STB has a different back panel configuration.

We recommend the use of cables with a Ferrite Core.

1. Connect an HDMI Cable between the HDMI connector on the TV and the HDMI connector on the DVD player/Set-Top Box.

External Connection

Connecting PC

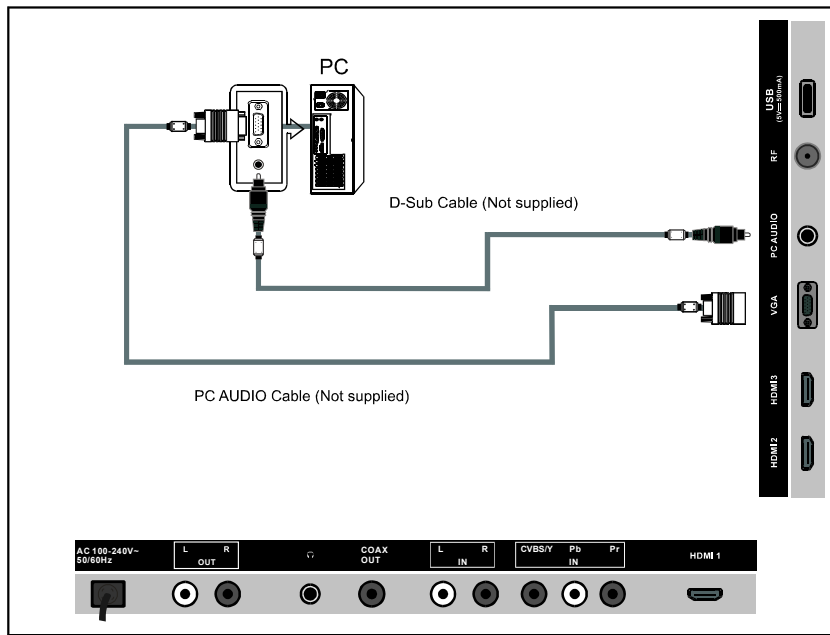

Each PC has a different back panel configuration.
The HDMI jacks do not support PC connection.
We recommend the use of cables with a Ferrite Core.

1. Connect a D-Sub Cable between RGB/PC IN connector on the TV and the PC output connector on your computer.
2. Connect the PC audio input jack on the TV.

External Connection

Connecting a Headphone

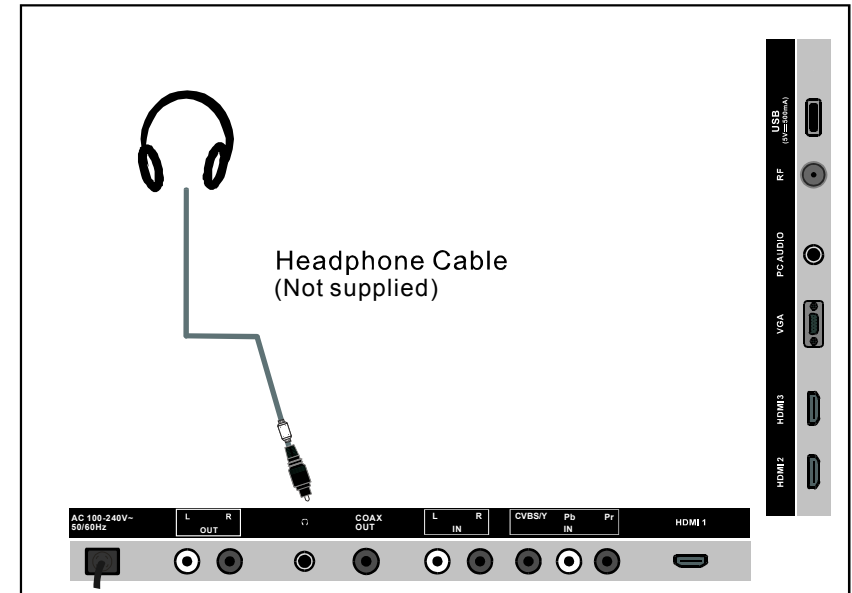

Plug headphone connector into headphone jack on the TV. Then the TV speaker will be muted.



Supporting signals

VGA/PC	Up to 1920 * 1080 @60Hz
COMPONENT	480i, 480p, 720p, 1080i, 1080p
HDMI	480i, 480p, 720p, 1080i, 1080p

Basic Operation

Turning the TV On and Off

How to turn the TV on or off

1. Insert the power cord plug into a polarized AC outlet.
2. Press  button on remote control or STANDBY button on the LED TV.
3. Normal picture will be displayed on the screen after 6 seconds. If no signal input, "No Signal" will be displayed on the screen.
4. If temporary POWER off is required, press  button on remote control or STANDBY button on the LED TV.
5. If you want to completely switch off the power for this unit, unplug the power cord from the electrical outlet.
6. After switching off the unit, do not turn on the TV again for at least 5 seconds.

Status indication lamp

Blue: In power on mode.

Red: In standby mode.

Auto power off

If there is no signal input in TV mode, the TV will automatically access the standby state in approximately 10 minutes.



Memory before turning TV off

The settings of picture and the preset channels will be memorized after turning off the unit. After restarting, the unit will work according to the mode set before being turned off.

OSD Menu Operations

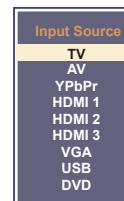
INPUT SOURCE SELECTION



Press SOURCE button to display the input source list;
Press / button to select the input source you want to watch;
Press ENTER button to enter the input source;

BASIC OPERATION

- Press MENU button on unit top or remote control to display the main menu.
- Press LEFT or RIGHT navigation button to select Picture/Sound/Time/Setup/Lock/Channel.
- Press DOWN navigation button to enter submenu page.
- Press UP or DOWN navigation button to select the option that want to adjust.
- Press LEFT or RIGHT navigation button to adjust selected option to desired value.
- Press RIGHT navigation button or ENTER button to enter next menu page.
- Press MENU button to return to previous menu page.
- Press EXIT button to exit menu page.



FIRST TIME INSTALLATION

If this is your first time turning on this TV, Setup Wizard will appear on the screen.

- Press UP or DOWN navigation button to select preferred item.
- Press LEFT or RIGHT navigation button to adjust the value.
- Press DOWN navigation button to Go to next step.

Menu Language

To choose your menu language.

Air/Cable

To choose your signal type: Air, Cable.

Cable System

To choose your Cable System: AUTO, STD, IRC, HRC.

NOTE: Cable System is adjustable only when your signal type is set to Cable.

Auto Scan

Highlight Auto Scan, press ENTER to search and store all available channels.



OSD Menu Operations

PICTURE

1. Picture Mode

Available options: User, Standard, Dynamic, Mild.

2. Contrast

The value of Contrast can be adjusted from 0-100.

3. Brightness

The value of Brightness can be adjusted from 0-100.

4. Color

The value of Color can be adjusted from 0-100.

5. Tint

The value of Tint can be adjusted from -50 to 50.

NOTE: Tint is adjustable only in certain TV system.

6. Sharpness

The value of Sharpness can be adjusted from 0-100.

NOTE: If the value of Contrast, Brightness, Color, Tint or Sharpness has been changed, the picture mode will turn to User automatically.

7. Color Temp. (Color Temperature)

Available options: Normal, Warm, Cool.



OSD Menu Operations

SOUND

1. Sound Mode

Available options: Standard, Music, Movie, User.

2. Bass

The value of Bass can be adjusted from 0-100.

3. Treble

The value of Treble can be adjusted from 0-100.

4. Balance

The value of Balance can be adjusted from -50 to 50.

NOTE: If the value of Bass or Treble has been changed, the sound mode will turn to User automatically.

5. Surround

This item is used to turn on/off Sound Surround function.

6. AVC (Auto Volume Control)

Available options: On, Off.

7. SPDIF Type

This item is used to select preferred SPDIF audio output type.
Available options: Off, RAW, PCM.

8. Audio Language

This item is used to select preferred audio language.

NOTE: This item is adjustable only for digital programs.

9. Accessibility

This item is used to make accessibility for people who are blind or visually impaired.

Voice Guide

Turn on/off voice Guide for some texts on screen.

Voice Guide: On, Off

Volume: Weak, Middle, Strong

Speed: Weak, Middle, Strong

Pitch: Weak, Middle, Strong

Video Description

Turn on/off Video Description.



OSD Menu Operations

TIME

1. Sleep Timer

Available options: Off, 5 min, 10 min, 15 min, 30 min, 45 min, 60 min, 90 min, 120 min, 180 min, 240 min.

2. Time Zone

Available options: Eastern, Central, Mountain, Pacific, Alaska, Hawaii, Atlantic.

3. Daylight Saving Time

Available options: On, Off.

NOTE: This item is adjustable only for digital programs.

4. Clock

When an available digital program is present, this unit will get Date and Time information automatically from current program. And it's not user adjustable.

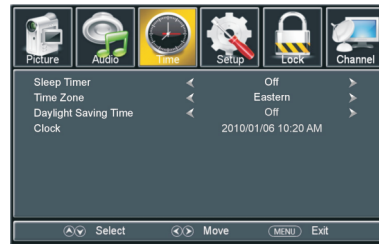

SETUP

1. Menu Language

This item is used to select preferred OSD menu language.

2. Transparency

This item is used to turn on/off Transparent OSD menu.

3. Zoom Mode

This item is used to select preferred zoom mode of display screen.

Available options: Normal, Wide, Zoom, Cinema.

NOTE: The available zoom mode may be different for different input source.

4. Noise Reduction

Available options: Off, Weak, Middle, Strong.

5. Advanced

This only adjustable for PC/VGA input signal.

6. Closed Caption

CC Mode

Available options: CC on Mute, Off, On.

Basic Selection

Available options: CC1, CC2, CC3, CC4, Text1, Text2, Text3, Text4.



OSD Menu Operations

SETUP

Advanced Selection

Available options: Service1, Service2, Service3, Service4, Service5, Service6.

Option

Mode

Available options: Default, Custom.

Font Style

Available options: Default, Font 0, Font 1, Font 2, Font 3, Font 4, Font 5, Font 6, Font 7.

Font Size

Available options: Default, Normal, Large, Small.

Font Edge Style

Available options: Default, None, Raised, Depressed, Uniform, Left Shadow, Right Shadow.

Font Edge Color

Available options: Default, Black, White, Red, Green, Blue, Yellow, Magenta, Cyan.

FG Color

Available options: Default, White, Red, Green, Blue, Yellow, Magenta, Cyan.

BG Color

Available options: Default, Black, Red, Green, Blue, Yellow, Magenta, Cyan.

FG Opacity

Available options: Default, Solid, Flashing, Translucent, Transparent.

BG Opacity

Available options: Default, Solid, Flashing, Translucent, Transparent.

NOTE: Advanced Selection and Option are adjustable only for digital programs.

7. DLC

This item is used to turn on/off Dynamic Luminance Control.

8. OverScan (HDMI mode only)

Turn on OverScan if users can not get full screen display in HDMI mode.

9. Restore Default

This item is used to reset to factory default settings.

10. CEC

- Press the RIGHT navigation button or OK button to enter it.

Note: Connect external HDMI device featured with HDMI CEC function first before following operations.

- Press the right arrow button or ENTER button to enter it.

CEC Control: Turn on/off HDMI CEC.

Device Auto Power Off: Turn on/off the device auto power off.

TV Auto Power On: If this function is enabled, the TV will power on automatically after turning on an externally connected CEC device.

Audio Receiver: Turn on/off the audio receiver.

Device Lists: Press Enter to display available devices.

Connect: Turn on/off the audio receiver.

Root Menu: Press Enter button into the root menu.

OSD Menu Operations

LOCK

- Input the password by pressing number buttons on remote control.
NOTE: The factory default password is 0000.

1. Change Password

- Press RIGHT navigation button or ENTER button to enter it.
- Press number buttons to input the new password and input it again to finish password changing.



2. System Lock

This item is used to turn on/off system lock.

3. US

TV

- Press RIGHT navigation button or ENTER button to enter it.
- Press navigation buttons to move the cursor.
- Press ENTER button to block or unblock it.

MPAA

Available options: N/A, G, PG, PG-13, R, NC-17, X.

4. Canada

Canada English

Available options: E, C, C8+, G, PG, 14+, 18+.

Canada French

Available options: E, G, 8 ans+, 13 ans+, 16 ans+, 18 ans+.

NOTE: US, Canada, RRT Setting and Reset RRT items are adjustable only when System Lock is On.

5. RRT Rating

This item is available only when viewing programs which contain related Advance Rating information.

6. Reset RRT

This item is used to reset RRT Rating.

7. Hotel Menu

- Press RIGHT navigation button or ENTER button to enter it.



Hotel Mode: turn on/off Hotel Mode.

Boot Setting: set Picture Mode, Default Volume, Max Volume, Boot Source.

(Boot Channel & Channel Select won't work if no TV signals.)

Hotel Lock: turn on/off Tuner Lock, Keypad Lock or Menu Lock.

Power Save: select desired Power Save time.

TV to USB: export data to USB device.

USB to TV: import data from USB device.

Reset Hotel Setting: reset above hotel setting.

OSD Menu Operations

CHANNEL

1. Air/Cable

This item is used to select preferred signal receiving type.



2. Auto Scan

- Press RIGHT or ENTER button to enter it.

2.1 Cable System

This item is used to select preferred cable system.

Available options: AUTO, STD, IRC, HRC.

NOTE: This item is adjustable only when your signal type is set to Cable.

2.2 Start to Scan

- Press RIGHT or ENTER button to start auto scanning.

- Press MENU or EXIT button to exit auto channel searching.



3. Favorite

- Press RIGHT or ENTER button to enter it.
- Press UP or DOWN navigation button to select preferred channel.
- Press ENTER button to label the selected channel as a favorite one or not.

4. Show/Hide

- Press RIGHT or ENTER button to enter it.
- Press UP or DOWN navigation button to select preferred channel.
- Press ENTER button to show or hide the selected channel.

5. Channel No.

- Press LEFT or RIGHT navigation button to select preferred channel number.

6. Channel Label

- Press RIGHT or ENTER button to enter it.
- Press LEFT or RIGHT navigation button to move the cursor.
- Press UP or DOWN navigation button to adjust the value.

NOTE: If no available channel is present, Favorite, Show/Hide, Channel No., and Channel Label will not be adjustable.

7. DTV Signal

This item is not user adjustable.

OSD Menu Operations

PC SETTINGS

- Press SOURCE button on unit top or remote control to set the unit in VGA mode.
- Press MENU button to display the main menu and select Setup item. Then press DOWN navigation button to enter Setup menu page.
- Press UP or DOWN navigation button to select Advanced and press RIGHT navigation button or ENTER button to enter it.

1. H-Pos (Horizontal Position)

Available range: 0-100.

2. V-Pos (Vertical Position)

Available range: 0-100.

3. Clock

Available range: 0-100.

4. Phase

Available range: 0-100.

5. Auto

If this item is entered, it will adjust the PC screen automatically.



USB

USB Operation

- Insert a USB memory device, which contains Photo or Music files, into USB slot.
- Press SOURCE button on the remote control to switch this unit to USB (or Media) mode.
- Press LEFT/RIGHT navigational button to choose between the Photo or Music page.
- Press UP/DOWN navigational button to select and press the OK button to open the file.

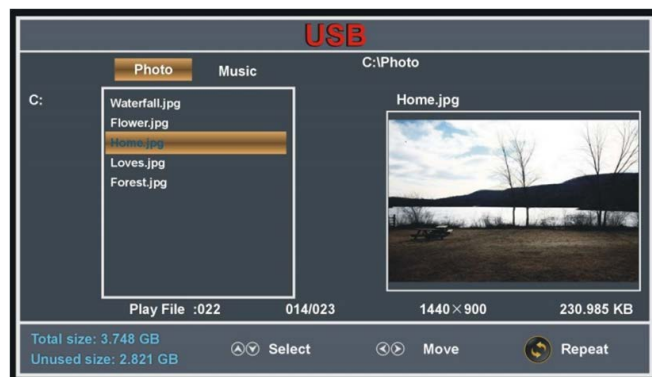

OSD Menu Operations

USB Operation

Photo Playback

- Select Phototab on the USB page.
- Press UP/DOWN navigation button to select preferred folder/file and press the ENTER button to enter a folder or play selected file.

Durning playback

- Press UP/DOWN navigation button to play previous/next photo.
- Press LEFT/RIGHT navigation button to rotate a photo counterclockwise/clockwise.
- Press EXIT button to return to Photo menu page.

Music Playback

- Select the MUSIC tab on the USB page.
- Press UP/DOWN navigation button to select preferred folder/file and press the ENTER button to enter a folder or play selected file.



Durning Playback

- Press INFO button to display/hide the tool bar.



- Press LEFT/RIGHT navigation button to select preferred option and press ENTER button to confirm it.

DVD Setup Menu

INITIAL SETTING(DVD)

Common procedure for initial settings

- Press SETUP button on remote control.
- Use the navigation buttons to select preferred item, and press ENTER button, each screen for setting the value is displayed. Then move the navigation buttons to set the item and press ENTER button to confirm the settings.
- Press SETUP button to close setup menu.
- Use LEFT or RIGHT navigation button to switch to another main setup item. Then press DOWN button to enter the sub-page.

1. GENERAL SETUP

1.1 TV DISPLAY - It is for selecting TV output mode.

- Option: 4:3 PanScan
4:3 Letterbox
16:9



1.2 OSD LANG - It is used to choose the desired language for different user. In this player, you can choose English or other languages.

1.3 SCREEN SAVER - When the player is not in use for 5 minutes, a screen saver will move across the screen to protect the TV.

- Options: ON: Screen saver is enabled
OFF: Screen saver is disabled

1.4 ANGLE MARK - It is used to select whether or not the multi-angle icon is display on screen when a Multi-angle disc is playing.

- Options: ON: Icon will be displayed
OFF: Icon will be turned off

1.5 LAST MEMORY - Enter another input source during DISC playback, and then back to DVD input source again, this unit will resume playback from the point where last playback was stopped, if LAST MEMORY is ON.

2. AUDIO SETUP

SPEAKER SETUP - It is used to set the speaker output levels.

- Options: STEREO
MONO L/R
MIX MONO



3. PREFERENCE

3.1 TV SYSTEM - Select desired TV system.

3.2 DEFAULT - It is used to reset to factory settings.



DVD OPERATION

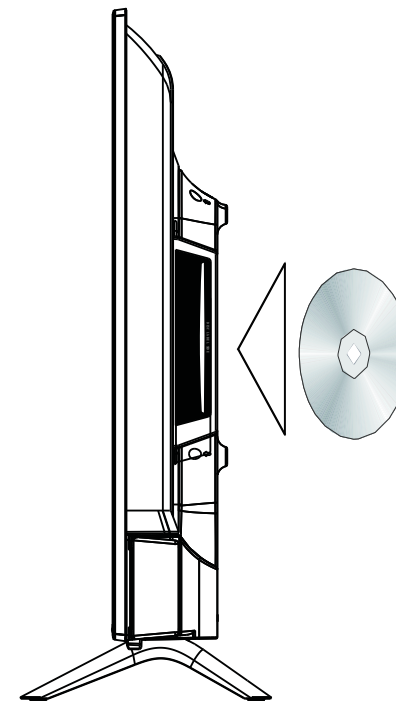

Media Support List:

Media Type	Format
Video	MPEG1, MPEG2
Audio	WMA, MP3
Photo	JPEG

Troubleshooting

If you have any problem, review the solutions for each symptom listed below. The following symptoms may have been caused by inappropriate adjustment rather than actual malfunction of the unit. If the trouble persists, contact the Customer Care Center, see back page for contact details.

Symptoms	Possible solutions
No power	Please check the power cord is plugged in and that the power outlet works. Unplug the power cord plug it in after 60 seconds and restart the TV.
No picture	Please check antenna connection. Station may be experiencing problems, please tune to another station. Please adjust the contrast and brightness settings.
Good picture but no sound	Please increase the volume. Please check TV is under mute mode, press MUTE button on the remote control. Please check sound settings.
Good sound but abnormal color or no picture	Please check the antenna connection.
No remote control	Batteries of remote control may have been exhausted, if necessary, please change the batteries. Clean the remote control lens. The distance between LED TV and remote control should be within 8m.
Full screen flickering under VGA	V-HEIGHT value may be set too big, restart computer and enter safe mode, then set monitor parameters to correct value according to adjustment description.
Horizontal stripes under VGA	Sample phase may be deflected, adjust phase according to picture position.
Colored dots may be present on the screen	This product is the high resolution LED display device and a few cell defects can occur in the manufacture of the LED. Several colored dots visible on the screen would be acceptable. in line with other LED manufacturers and would not mean that the LED is faulty. We hope you will understand that it could not be changed or refunded.

Picture defects and the reason



Snowy Picture

Snowy picture is usually due to weak signal. Adjust antenna or install an antenna amplifier.



Double Image or Ghosts

Double images are usually caused by reflections from tall buildings. Adjust the direction of the antenna or raise it.



Radio Wave Interference

Wave patterns are moving on the screen, which are usually caused by nearby radio transmitters or short-wave receiving equipment.



High Temperature Electrothermal Interference

Diagonal or herringbone patterns appear on the screen or part of picture is missing. This is probably caused by high temperature electrothermal equipment in a nearby hospital.