



# 210” Home Theater 1080P LCD Projector Player

NVP-3003C



## User Manual

Please read carefully before using product and  
keep for future reference

## CONTENTS

Important Safety Instructions .....	2
FCC Warning .....	3
Package Listing .....	4
Remove & Close The Lens Cover .....	4
Boot Operation Guide .....	5
Distance Between The Projector And Screen .....	5
Viewing Options .....	6
Placing Your Projector On Ceiling .....	6
Adjust The Vertical Location .....	7
Adjust The Focus And Keystone .....	7
Functional Overview .....	8
Remote Control .....	9
Install Remove Remote Control Batteries .....	10
Connection Instructions .....	10
Multimedia Connection .....	11
HDMI Device Connection .....	12
AV Video Device Connection .....	13
Audio Devices Connection .....	13
Using Projector Menu 1.0 .....	14
Using Projector Menu 2.0 .....	14
Using Projector Menu 3.0 .....	15
Using Projector Menu 4.0 .....	15
FAQ .....	16
Specifications .....	17
Warranty Exclusions .....	18

## IMPORTANT SAFETY INSTRUCTIONS

When using electronic equipment, basic safety precautions must be followed, including the following:

**WARNING:** To reduce the risk of electric shock, fire or injury to persons:

1. Read all instructions before using the unit.
2. Use this unit only for its intended use as described in this manual.
3. Do not operate this unit if it has a damaged cord or plug, is not working properly or has been damaged or dropped. If the supply cord is damaged, it must be replaced by the manufacturer or its service agent or a similarly qualified person in order to avoid a hazard.
4. **WARNING:** Do not allow children to use the unit without supervision.
5. **WARNING:** Liquids and foodstuffs must not be spilled or dropped into the unit.
6. **WARNING:** It is hazardous for anyone other than a trained person to carry out any service or repair operation.
7. This unit is not intended for use by persons (including children) with reduced physical, sensory or mental capabilities, or lack of experience and knowledge, unless they have been given supervision or instruction concerning use of the product by a person responsible for their safety.
8. Children must be supervised to ensure that they do not play with the unit.
9. Never leave the product unsupervised. Switch off the product when it is not in use, even if this is only for a short while.
10. The unit must be free-standing. It must not be placed in a cabinet.
11. The temperature of accessible surfaces may increase when the unit is operating.
12. This unit is not intended to be operated by means of an external timer or separate remote control.
13. If smoke is emitted, switch off and unplug the unit immediately.
14. **Cleaning:** Unplug this product from the wall outlet before cleaning. Do not use liquid cleaners or aerosol cleaners. Use a slightly dampened cloth for cleaning and immediately wipe dry.
15. **Attachments:** Use only attachments recommended by the manufacturer. Use of other attachments may be hazardous.
16. **Water and Moisture:** Do not use this product near water (e.g., near a bath tub, washbowl, kitchen sink, laundry tub, in wet basements, or near a swimming pool and the like).
17. **Ventilation:** Slots and openings in the cabinet are provided for ventilation to ensure reliable operation of the product and to protect it from overheating. These openings should never be blocked by placing the product on a bed, sofa, rug, or other similar surface. This product should not be placed in a built-in installation such as a bookcase or rack unless proper ventilation is provided.
18. This unit must not be exposed to dripping or splashing and objects filled with liquids, such as vases, must not be placed on the apparatus.
19. **Replacement parts:** When replacement parts are required, be sure that your service technician has used replacement parts specified by the manufacturer or that have the same characteristics as the original part. Unauthorized substitutions may result in fire, electric shock, or other hazards.
20. **Safety check:** Upon completion of any service or repairs to this product, ask the service technician to perform safety checks to ensure that the product is in proper operating condition.
21. **Overloading:** Do not overload wall outlets, extension cords, or integral convenience receptacles as this may cause a fire or an electric shock.
22. When the AC / DC adapter is used as the disconnect device, the disconnect device must remain readily operable. To completely disconnect the power input, the AC / DC adapter must be completely disconnected from the mains.

## IMPORTANT SAFETY INSTRUCTIONS

For optimal performance view in a dark environment.

Please note: Projector brightness is measured in ANSI lumens. Your viewing environment is the deciding factor on how many lumens your projector needs.

- Please use the included AC power cable to power the machine. Only use the included accessories specified by the manufacturer.
- It is normal for the machine to generate heat during operation. To prevent overheating, do not block the ventilation openings.
- CAUTION: Do not look straight into the projector lens while on, as it may cause serious eye damage. Do not touch the lens.
- Clean only with a dry cloth.
- To reduce the risk of fire or electric shock, do not expose the device to rain or moisture. Objects filled with liquids, such as vases, should not be placed on these devices, as this may lead to potential accidents that damage the device.
- Protect this device from overexposure to direct sunlight, heat, large temperature fluctuations, and moisture. Avoid extreme temperatures. The suitable operating and storage temperature for this device and its accessories are 0°C to 35°C / 0°F to 95°F.
- Avoid any type of impact, as this may damage the internal components.
- Never attempt to repair or service this device as it is dangerous to do so and will void the warranty.
- Please contact the technical team (details at the end of the manual) for support, service or repair.

## FCC WARNING

WARNING: Changes or modifications to this unit not expressly approved by the party responsible for compliance, will void the user's authority to operate the equipment.

NOTE: This equipment has been tested and found to comply with the limits for a Class B digital device, pursuant to Part 15 of the FCC Rules. These limits are designed to provide reasonable protection against harmful interference in a residential installation. This equipment generates, uses and can radiate radio frequency energy and, if not installed and used in accordance with the instructions, may cause harmful interference to radio communications. However, there is no guarantee that interference will not occur in a particular installation. If this equipment does cause harmful interference to radio or television reception, which can be determined by turning the equipment off and on, the user is encouraged to try to correct the interference by one or more of the following measures:

- Reorient or relocate the receiving antenna.
- Increase the separation between the equipment and receiver.
- Connect the equipment into an outlet on a circuit different from that to which the receiver is connected.
- Consult the dealer or an experienced radio / TV technician for help.

## PACKAGE LISTING

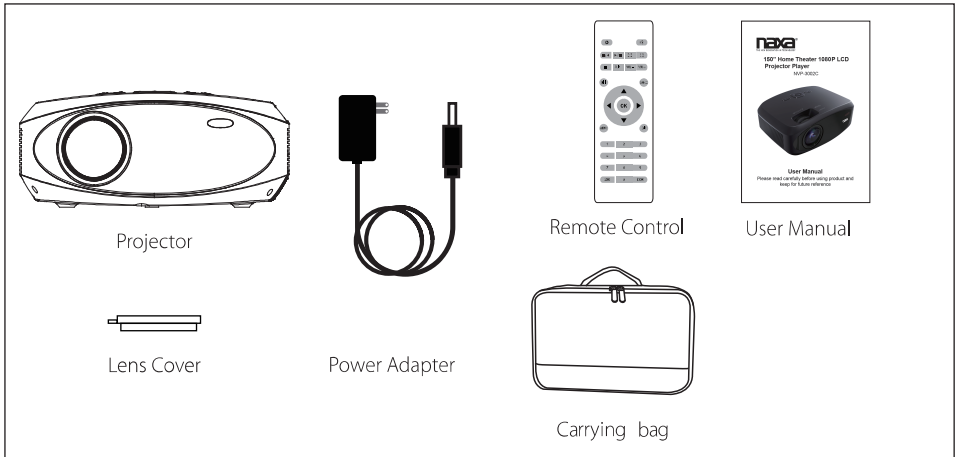

NOTE: Accessories are packed at the bottom of the package.

### Carrying Bag

## REMOVE & CLOSE THE LENS COVER

Remove the lens cover before using

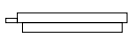
Lens Cover  Remove

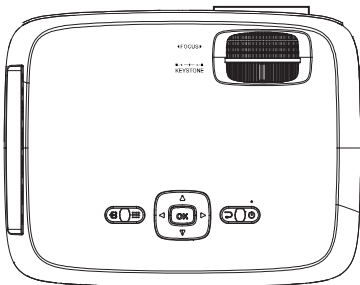

Close the lens cover when not using the unit

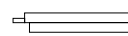
Lens Cover  Close

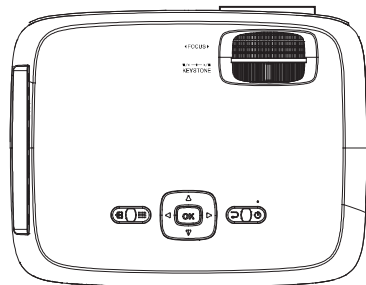

## BOOT OPERATION GUIDE

### Turn On

1. Press the power button.
2. The projector will turn on after 5 seconds.

### Turn Off

1. Turn off the power button.
2. Unplug the power switch.

NOTE: Please turn off the projector before unplugging the power source, so as not to affect the life and operation of the projector.

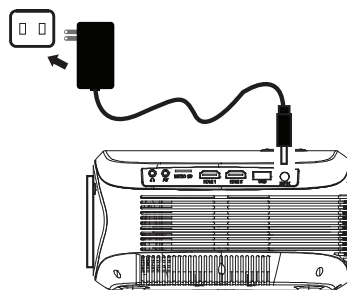

## DISTANCE BETWEEN THE PROJECTOR AND SCREEN

Project Distance	1 m	2 m	3 m	4 m	6 m
Project Size	30 inch	68 inch	98 inch	120 inch	200 inch
Light, brightness, etc. will affect the projection distance. This guide is for reference purposes only.					
Projector position					
It is recommended that the projector is placed in the centre, in front of the screen.					

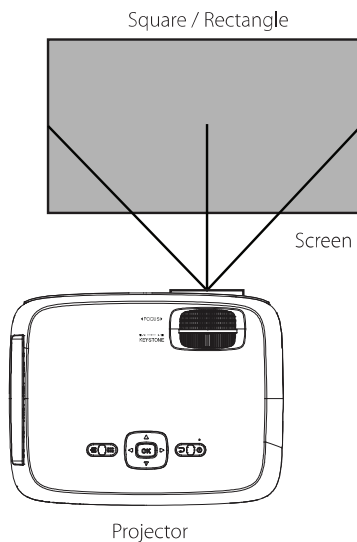

## VIEWING OPTIONS

The projector can be used to project onto a wall or onto a screen. It can be mounted from the ceiling or on a table. When projecting from the rear position, a special screen will be needed (not included) to display the image. Be sure to aim the remote at the sensor on the front or rear of the projector.



Front Table

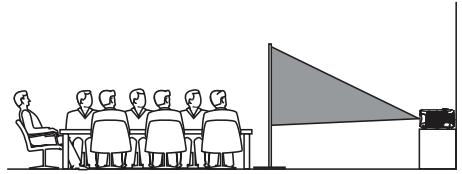

Rear Ceiling

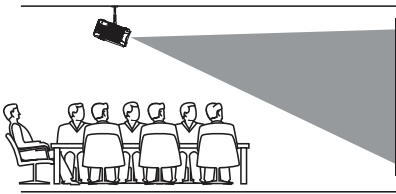

Front Ceiling

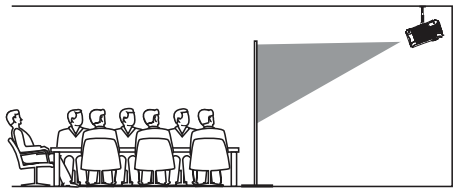

Rear Ceiling

## PLACING YOUR PROJECTOR ON CEILING

When installing the projector on the ceiling, please purchase a projector mount recommended by an installation professional and follow the instructions that come with the mount.

Before installing the projector on the ceiling, please check to make sure the ceiling structure can support the weight of the projector and the mount. If in doubt, please consult an authorised installation professional.

NOTE: Projector mount and screw(s) not included

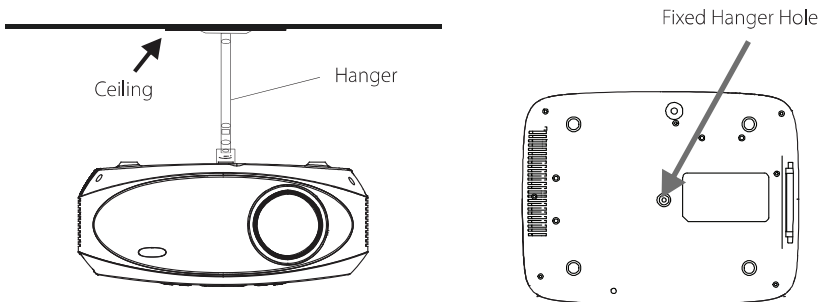

## ADJUST THE VERTICAL LOCATION

Follow below picture to adjust the vertical location

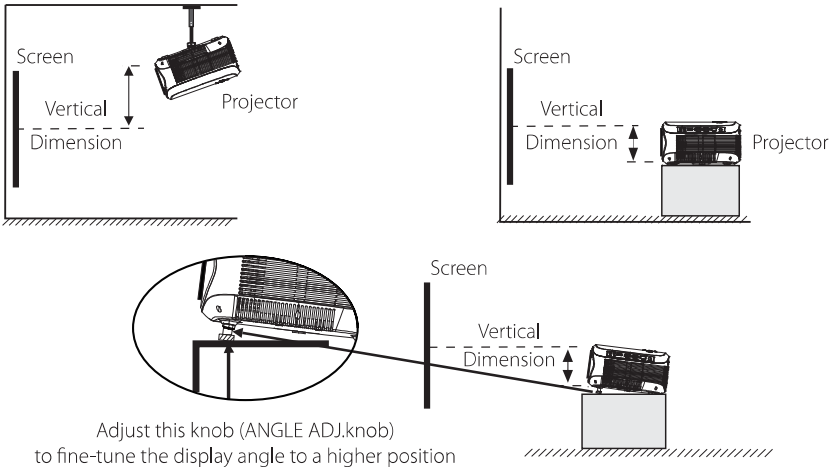

## ADJUST THE FOCUS AND KEystone

Focus

As illustrated, adjust the lens focus wheel until you get a clear picture.

Keystone

As illustrated, keystone correction to facilitate horizontal angles.

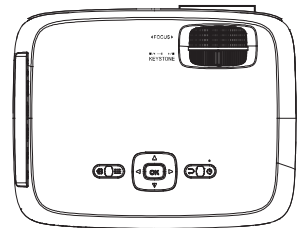



## FUNCTIONAL OVERVIEW

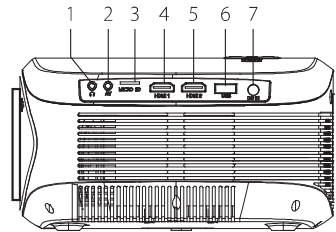
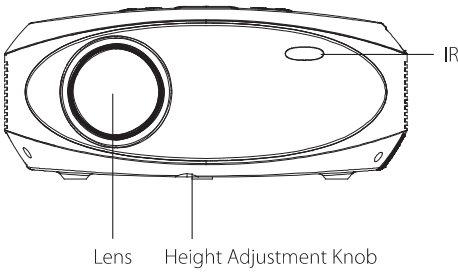
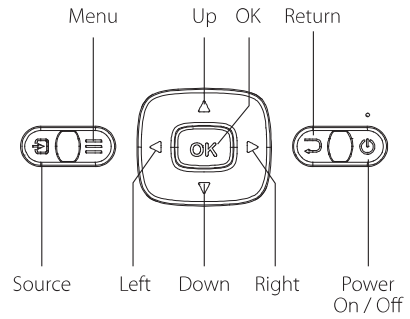
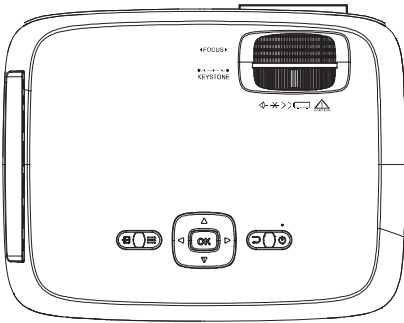

1. Audio Out Port
2. AV In Port
3. Micro SD (TF) Port
4. HDMI Port 1

5. HDMI Port 2
6. USB Port
7. DC Input Port

## REMOTE CONTROL

Power: Press to power on.  
Press twice to power off.

Previous ◀◀ / Next ▶▶  
Press to skip between chapters or tracks.

Stop ■  
Press to stop playback.

Flip  
Press to display image 180°.

Play / Pause ▶▶  
Press to play or pause an individual chapter or track.

Arrows / OK  
Press to navigate and confirm selections in settings and other menus.

Menu  
Press to access projector settings.

Go To/ Number Keypad  
Press to enter specific or track numbers.  
Use Play button to begin playing.

Mute  
Press to mute volume.

Back ◀◀ / Fwd ▶▶  
Press to search through an individual chapter or track.

Vol+ / Vol-  
Press to adjust audio level.

Source  
Press to select media source (AV, PC, HDMI, MEDIA).

Exit  
Press to exit menus.

Zoom  
Press to zoom display image in or out.

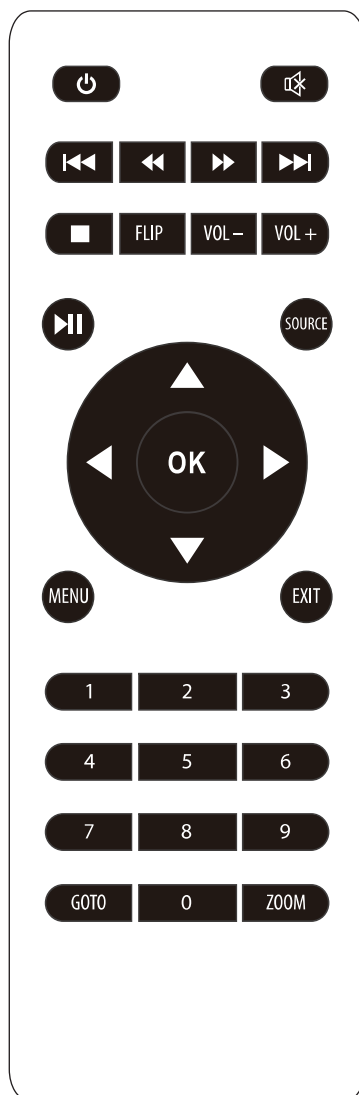

## INSTALL REMOVE REMOTE CONTROL BATTERIES

Remove the battery compartment cover on the back of your remote by carefully sliding to open. The battery cover can then be lifted away. Fit the correct batteries (2 x AAA batteries not included), referring to the polarity markings. Finally, replace the cover.

### NOTE:

- Batteries must never be exposed to excessive heat such as sunshine, fire, or the like.
- Make sure that the batteries are installed correctly.
- Only same or equivalent type batteries are recommended.
- Do not dispose of batteries in a fire as the battery may explode or leak.
- Do not try to recharge a battery.
- Do not mix old and new batteries.
- Do not mix alkaline, standard (carbon-zinc), or rechargeable (ni-cad, nimh, etc) batteries.

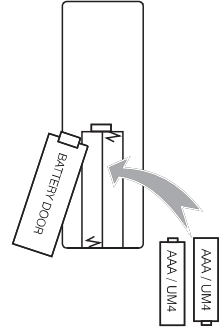

## CONNECTION INSTRUCTIONS

### Select an input source

When the projector is turned on, the image below will be displayed. Choose an input source. (AV / HDMI 1 / HDMI 2 / Media Player) by pressing the "Source" button on the projector touch panel or remote control. You can connect different devices to the projector, according to the following connection instructions.

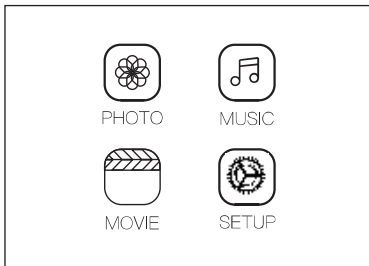

Interface

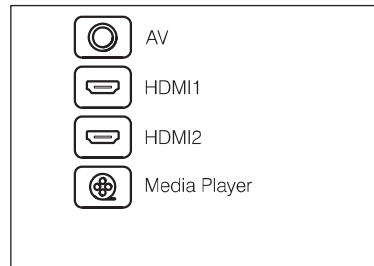

Source

## MULTIMEDIA CONNECTION

Insert USB / Micro SD card into the corresponding slots (as shown in the picture). Choose media player source, select "Video," "Music," "Picture" to enter the content you want to play.

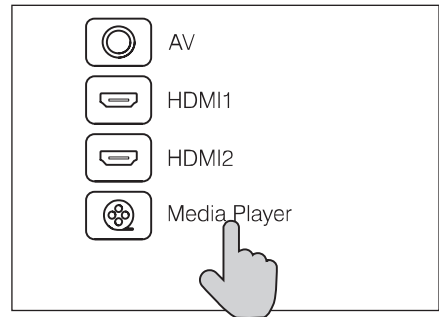
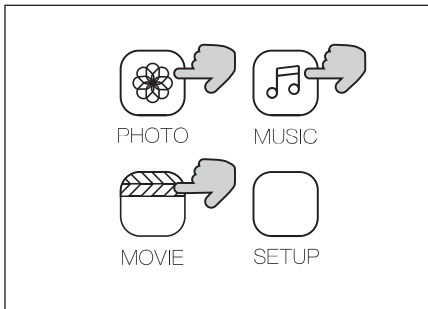
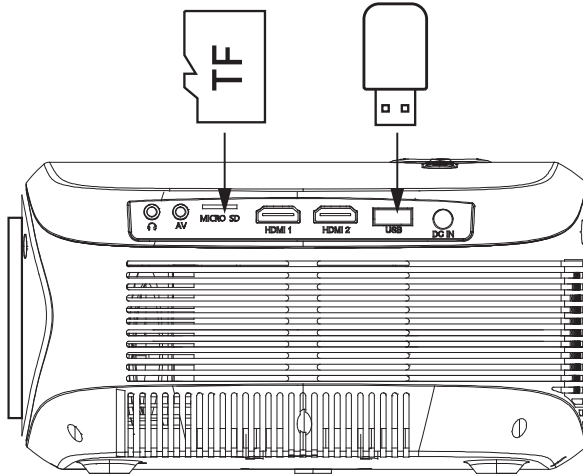

## HDMI DEVICE CONNECTION

The projector can connect to devices with HDMI input function. It is compatible with laptops, DVD Players, Blu-ray players, Chromecast, TV stick, etc. An HDMI cable is not included. The projector is equipped with 2 HDMI input ports.

1. To connect a device to the projector via "HDMI 1" port, please choose "HDMI 1" input source.
2. To connect via the "HDMI 2" port, please choose the "HDMI 2" input source.

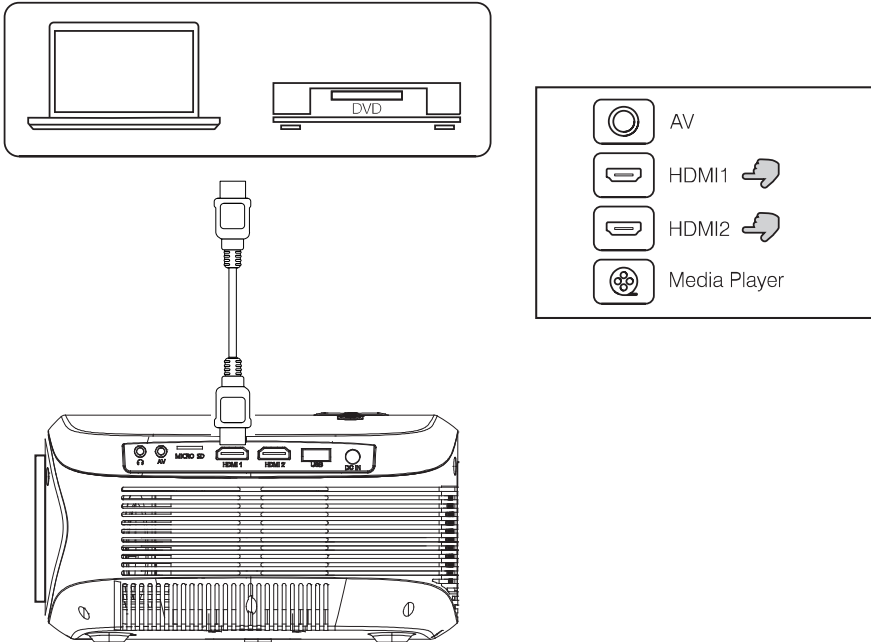

## AV VIDEO DEVICE CONNECTION

Connect the projector AV interface with an AV cable (not included), as illustrated.

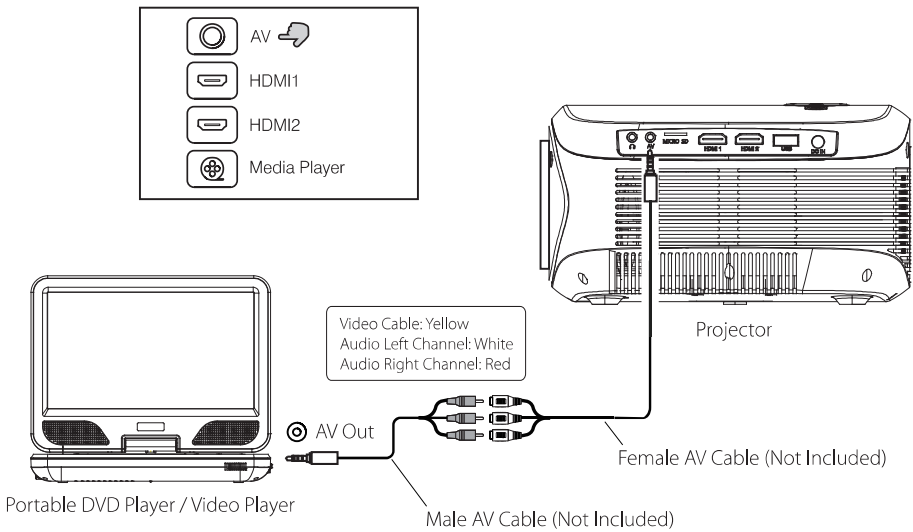

## AUDIO DEVICES CONNECTION

The projector can connect to a headphone and to a wired audio system using a 3.5mm jack (not included)

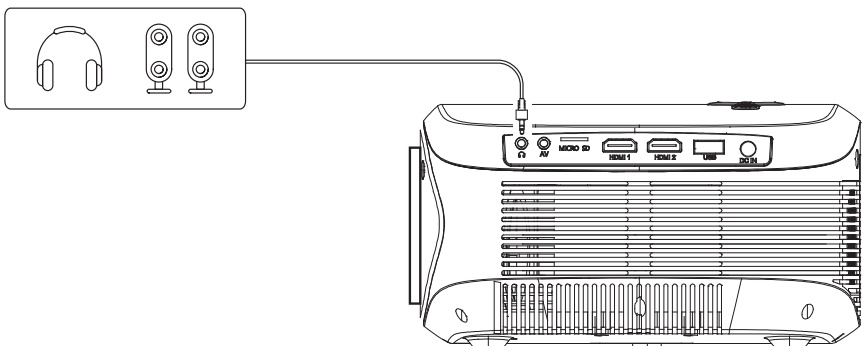

## USING PROJECTOR MENU 1.0

Press  button to enter projector menu. Press again to return to previous status.

Use  button to select manual page.  
The menu will be shown on the upper right of the screen.

1. Picture Mode  
Select Vivid, User (custom), Soft or Standard
2. Contrast, Brightness, etc  
Set picture mode to "User" to adjust these settings
3. Colour Temperature  
Select Warm, Cool, or Medium
4. Aspect Ratio  
Select 16:9, 4:3 or Auto
5. Noise Reduction  
Select Off, Low, Middle, High or Default
6. Screen

Color Temper...(Temperature)	
Customer Define	Parameter
Red	0-100
Blue	0-100
Green	0-100

Aspect Ratio

4:3 The signal in a 4:3 aspect ratio projection image

16:9 The signal in a 16:9 aspect ratio projection image



## USING PROJECTOR MENU 2.0

Press  button to enter projector menu. Press again to return to previous status.

Use  button to navigate the menu options,  
menu picture illustrated for reference.

1. Sound Mode - Select Music, Movie, User (custom), Sports, or Standard
2. Treble, Bass - Set sound mode to "User" to adjust these settings
3. Balance - Adjust the audio balance
4. Auto Volume - Select Off or On



Sound Mode - User

Treble: Parameter 0-100, Bass: Parameter 0-100

## USING PROJECTOR MENU 3.0

Press  button to enter projector menu. Press again to return to previous status.

Navigate the menu options, menu picture illustrated for reference.

1. OSD Language  
Select different language, as illustrated below
2. Restore Factory Default  
Select Y or N
3. Projection Mode  
Select Front, Rear, Ceiling Front, Ceiling Rear
4. Info  
Display the unit information as below



Model: PRO 10
SN:
BLAUPUNKT
SW Ver: V7.0
Logo: BLAUPUNKT

English	Hrvatski	Nederlands	Simplified Chinese
Francaise	Deutsch	Slovenina	Slovak
Espanol	Italiano	Norsk	
Portugues	Magyar	Srpski	
EsKy	Polski	Svenska	
Dansk	Romnete	Suomi	

## USING PROJECTOR MENU 4.0

Press  button to enter projector menu. Press again to return to previous status.

Navigate the menu options, menu picture illustrated for reference.

1. Clock --  
Select clock and set Day, Month, Year, Hour, and Minutes
2. Off Timer  
Select turn off timer to set Day, Hour, and Minutes
3. On Timer  
Select turn on timer to set Day, Hour, and Minutes
4. Sleep Timer  
Set sleep timer and select Off, 10 Min, 20 Min, 30 Min, 60 Min, 90 Min, 120 Min, 180 Min, 240 Min
5. Auto Sleep  
Set auto sleep function and select Never, 4 Hour, 6 Hour, 8 Hour





## FAQ

Q: The projector is not turning on.

A: Please be sure that the AC power cable is plugged in tightly. Press the power switch on the projector's panel or use the remote control to turn it on.

Q: The projector is turned on, but no image is displayed.

- A:
1. Please make sure your device is connected to the projector correctly.
  2. Check the lens cover has been removed.
  3. Check if the input signal source is correct, and then switch into projection mode. Wait for a while and operate it again.
  4. Please make sure that the video source is equal to or less than 1080P.
  5. If it is still not working, please contact us for further support.

Q: The lamp (bulb) switches off after a period of time.

- A:
1. Leave the projector to cool for a few moments.
  2. Once cooled, check if anything is blocking the ventilation vents.
  3. Turn on the projector.

If the issue persists please contact us.

Q: When playing a video, image is displayed but there is no sound.

A: If you connect to your laptop via a HDMI adaptor, the audio cable of the adapter needs to be plugged into the audio output port from your laptop to the projector, with a 3.5mm audio jack.

Q: The projection is not bright enough.

A: We recommend using the projector in a relatively dark environment to bring out the best image brightness. This projector is designed for home entertainment and is not recommended for Power Point or other business presentations.

Q: Spots on the screen.

A: Use a vacuum cleaner to clean the lens. If cleaning does not resolve things, please contact your support provider for further assistance.

Q: I get a blurry image?

A: The recommended projection distance is 1-3m. Please adjust the keystone correction to get a rectangular image first, then adjust the focus to get a clear image. The optimal focus is obtained when the pixels are clearly visible. If the projection size is too large, the focus near the screen edges may be less sharp than at the screen centre.

Q: My projector noise is too loud, is it broken?

A: The projector noise comes from the fan of its cooling system. The projector generates heat during operation as the light bubble produces strong light to make a bright image. It is normal for the projector to make a loud noise. The brighter the image, the louder the sound will be. You can place the projector far from where you are, or you can connect a loudspeaker to the projector to cover up the noise.

Q: Can you adjust the brightness / sharpness of the video?

A: Path: Setup (Click "Source")-picture-picture mode (choose "User")-adjust via remote control.  
For non-professionals, we recommend using the default value.

## SPECIFICATIONS

Light Source Type	LED
Display Native Resolution	1920 x 1080
Supported Video Resolution	1080p, 1080i, 720p, 576i, 480p, and 480i
Included Adaptor Connects To DC Input Of The Unit	Input AC 110-240V, 50/60Hz, Output DC 19V 4.75A
Display Colour	7000K~8000K
Dolby Sound	Not supported
Connection Types	HDMI / USB / Micro USB (TF) / AV / Audio
Input	HDMI x 2 / AV x 1 / Micro USB (TF) x 1 / USB x 1
Output	Audio Out x 1
USB Port	Support USB device up to 64GB
SD Card	Support SD Card up to 64GB
Supported Image Formats	*.jpg *.png *.bmp
Supported Audio Formats	*.mp3 *.wma *.ogg *.aac *.flac
Supported Video Formats	*.avi *.flv *.rmvb *.mkv *.mp4 *.3gp *.mov *.mpg *.mpeg *.ts *.tp *.vob
Dimensions	254 x 197 x 110 mm

For optimal performance, please view in dark environment.

PLEASE NOTE: Projector brightness is measured in ANSI lumens. Your viewing environment is the deciding factor on how many lumens your projector needs.

## WARRANTY EXCLUSIONS

The warranty will not be valid if:

1. The product has not been installed, operated or maintained in accordance with the manufacturers operating instructions provided with the product.
2. The product has been used for purposes other than its intended function.
3. The product has been used for purposes other than household use.
4. The damage or malfunction of the product is caused by any of following conditions:
  - Incorrect voltage
  - Accidents (including liquid or moisture damage)
  - Misuse or abuse of the product
  - Faulty or improper installation
  - Mains supply problems including power spikes or lightning damage
  - Infestation by insects
  - Tampering or modification of the product by persons other than authorised service personnel
  - Exposure to abnormally corrosive materials
  - Insertion of foreign objects into the unit
  - Used with accessories not pre-approved by BLAUPUNKT

Please refer to and heed all warnings and precautions in the user manual.

BLAUPUNKT will not be held responsible for damage caused by power surges or lightning strikes.

BLAUPUNKT will not be held responsible for non-compatibility with third party devices.

Due to continuous product development, specifications are subject to change without prior notice.