

ENGLISH

**naxa**<sup>®</sup>

## INSTRUCTION MANUAL



### HOME THEATRE SYSTEM

ND-863

IMPORTANT  
READ THESE INSTRUCTIONS  
BEFORE USE AND RETAIN  
FOR FUTURE REFERENCE.



# SAFETY INFORMATION

TO REDUCE THE RISK OF FIRE AND ELECTRIC SHOCK, DO NOT EXPOSE THIS UNIT TO RAIN OR MOISTURE.



**CAUTION** : To reduce the risk of fire and electric shock, do not remove the cover (or back) of the unit. Refer servicing only to qualified service personnel.



The lightning flash with arrowhead symbol, within an equilateral triangle, is intended to alert the user to the presence of uninsulated "dangerous voltage" within product's enclosure that may be of sufficient magnitude to constitute a risk of electric shock.

The exclamation point within an equilateral triangle is intended to alert the user to the presence of important operation and servicing instructions in the literature accompanying the appliance.

**WARNING: TO REDUCE THE RISK OF FIRE OR ELECTRIC SHOCK, DO NOT EXPOSE THIS APPLIANCE TO RAIN OR MOISTURE.**

**CAUTION: TO PREVENT ELECTRIC SHOCK, MATCH WIDE BLADE OF PLUG TO WIDE SLOT, FULLY INSERT.**

## IMPORTANT SAFEGUARDS

In addition to the careful attention devoted to quality standards in the manufacture of your video product, safety is a major factor in the design of every instrument. However, safety is your responsibility, too. This sheet lists important information that will help to assure your enjoyment and proper use of the video product and accessory equipment. Please read them carefully before operation and using your video product.

## Installation

Read all instructions carefully, even if you are familiar with the appliance.

1. This appliance is not intended for use by children or infirm persons without supervision.
2. Children should be prevented from playing with the appliance.
3. This appliance should be placed on a dry, level surface before it is operated.
4. **INDOOR USE ONLY** this appliance is not intended for outdoor use.
5. Do not expose this appliance to rain or moisture. Do not immerse the appliance in water or any other liquid.
6. Do not place items filled with liquids, such as vases, on the appliance. Do not expose the appliance to dripping or splashing liquids.
7. This appliance is not intended for use in bathrooms, laundry areas or similar moist locations. Never locate this appliance in the immediate surroundings of, or where it may fall into, a bath, basin, washtub, shower or swimming pool.

8. Do not place naked flame sources, such as candles, on the appliance.
  9. Do not locate the appliance or cord near heat sources such as radiators, heaters, air ducts or direct sunlight.
  10. Do not block any of the ventilation openings. Ensure that vents are not covered by newspapers, tablecloths, curtains, etc. Do not install in a tight-fitting cabinet.
  11. Do not insert or allow foreign objects to enter any grille openings.
  12. Do not run the cord under carpeting. Instead, arrange the cord away from traffic areas where it will not become a trip hazard.
  13. To disconnect the appliance, turn the appliance off, switch off the power outlet and remove the plug from the power outlet.
  14. Do not misuse the cord. Never carry the appliance by the cord or pull to disconnect it from the outlet. Instead, grasp the plug and pull to disconnect.
  15. Do not operate the appliance if it has a damaged cord or plug; after the appliance malfunctions; or has been dropped or damaged in any way. Consult Service Technician for examination.
  16. Use of controls or adjustments, or performance of procedures other than those specified herein, may result in hazardous radiation exposure.
- Caution**

Do not open do not attempt to repair, disassemble or modify this appliance.

Dangerous high voltages exist inside this appliance.

This appliance is only to be serviced by Service Technician. There are no user-serviceable parts inside. Do not look at laser pick-up directly. Do not touch the lens.

# SAFETY INFORMATION

## Installation Warnings

**Ventilation** Slots and openings in the case are provided for ventilation to ensure reliable operation of the video product and to protect it from overheating. These openings must not be blocked or covered. The openings should never be blocked by placing the product on a bed, sofa, rug, or heat register. This product should not be placed in a built-in installation such as a bookcase or rack, unless proper ventilation is provided or the video product manufacturer instructions have been followed.

**Outdoor Antenna Grounding** If an outside antenna or cable system is connected to the video product, be sure the antenna or cable system is grounded so as to provide some protection against voltage surges and buildup static charges. ANSI/NFPA No. 70-1984 provides information with respect to proper grounding of the mast and supporting structure, grounding of the lead-in wire to an antenna-discharge unit, connection to grounding electrodes, and requirements for the grounding electrode.

**Power Lines** An outside antenna system should not be located in the vicinity of overhead power lines, other electric light or power circuits, or where it can fall into such power lines or circuits. When installing an outside antenna system, extreme care should be taken to keep from touching or approaching such power lines or circuits, as contact with them might be fatal. Installing an outdoor antenna can be hazardous and should be left to a professional antenna installer.

**Lightning** For added protection for this product during a lightning storm, or when it is left unattended and unused for long periods of time, unplug it from the wall outlet and disconnect the antenna or cable system. This will prevent damage to the video product due to lightning and power line surges.

## Compulsory Warnings

If the supply cord is damaged, it must be replaced by service Technician, in order to avoid a hazard. This product has not been designed for any uses other than those specified in this booklet.

### Laser Safety

This compact disc player is classified as a CLASS 1 LASER PRODUCT.

Only qualified service personnel should remove the cover or attempt to service this device due to possible eye injury.

Invisible laser radiation when open and interlock failed or defeated.

Avoid direct exposure to beam.

# FEATURES

DVD,VCD,SVCD,CD,CD-R,MP3,  
MP4 compatible

TV format:

4:3 / 16:9 screen format select

Video output:

Composite Video output

S-Video output

YPbPr output

Audio output:

Down-mix stereo output

Coaxial output

DVD features:

Multi Subtitle select

Multi Language select

Multi Angle select

Other features:

On screen control menu

Digital zooming

Slow motion forward

Auto screen saver

## Packing List

1. Remote control ..... 1 piece
2. AV connection line ..... 1 piece
3. Battery ..... 1 pair
4. User's Manual ..... 1 book

# CONTENTS

Page

WARNING	
IMPORTANT NOTICE	
FEATURES	
ESSENTIAL SETUP .....	1
INTRODUCTION .....	2
About DVD .....	3
About the player .....	4
Remote control .....	5
SYSTEM CONNECTION .....	6
GETTING STARTED	
Play a disc .....	7
Screen saver .....	8
FUNCTION BUTTONS	
[ Power ], [ Open / Close ], [ Play / Pause / Stop ] .....	9
[ Skip ], [ Slow ], [ Select an Item ], [ Title / Menu ], [ Clear ] .....	10-11
[ Angle ], [ Subtitle ], [ Audio ], [ Number Keys ] .....	12-13
[ Search a desired section ] .....	14
[ Repeat ], [ A-B ], [ Zoom ], [ Mute ], [ PBC ], [ R/L ], .....	15-17
[ Programme ] .....	18
[ Return ] [ P/N ] .....	19
ON SCREEN DISPLAY	
DISPLAY DVD mode .....	20
DISPLAY Mp3 mode .....	21
SETUP MENU	
LANGUAGE MENU .....	22
OSD Menu / Subtitle / Audio / DVD Menu	
VIDEO MENU .....	22
TV screen	
AUDIO MENU .....	23
Digital output	
TROUBLE SHOOTING .....	24-25
SPECIFICATIONS .....	26

# ESSENTIAL SETUP

## Video outputs

The player is equipped with the following video output ports:

Composite Video, S-Video and Y Pb/Cb Pr/Cr ,  
Coaxial output

### For TV System setting

TV System menu is to set up the output TV system to PAL or NTSC

1. In STOP mode, press SETUP button ,  
setup menu appears.
2. Press DOWN button , highlight "Video" icon.
3. Press RIGHT button , and scroll down to highlight "TV System".
4. Press ENTER button, sub menu appears. Highlight "NTSC" or "PAL" or "AUTO", press ENTER button.
5. Press SETUP button to quit.

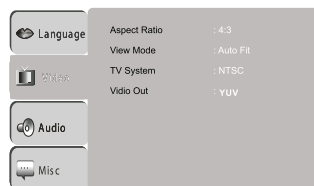

## Default setting NTSC

When a DVD disc of NOT correct TV system is loaded or the TV set of NOT correct TV system with the player, a distorted video signal may come out on the screen.

# INTRODUCTION

Loading batteries to the remote control

- Remove the battery compartment cover.
- Load two AAA (UM-4 or R03) batteries into the battery compartment.
- Make sure that the batteries have been inserted in the correct polarities matching to the symbols +, - marked in the battery compartment. Close the battery compartment cover.
- When replacing batteries, replace both batteries. Do not mix new and used batteries operating together, otherwise, the operation lifetime will be much shorter than normal.
- Remove the batteries if the unit will not be used for a prolonged period of time.

The remote control transmits a directional infrared beam. Be sure to aim the remote control directly at the infrared sensor of the unit during operation.

If the sensor has been covered or there is a large object between the remote control and the sensor, the sensor will not respond.

The sensor may be not able to receive the remote signal when it is exposed to direct sunlight or a strong artificial light (fluorescent or strobe light). In this case, change the direction of the light or reposition the unit to avoid direct lighting.

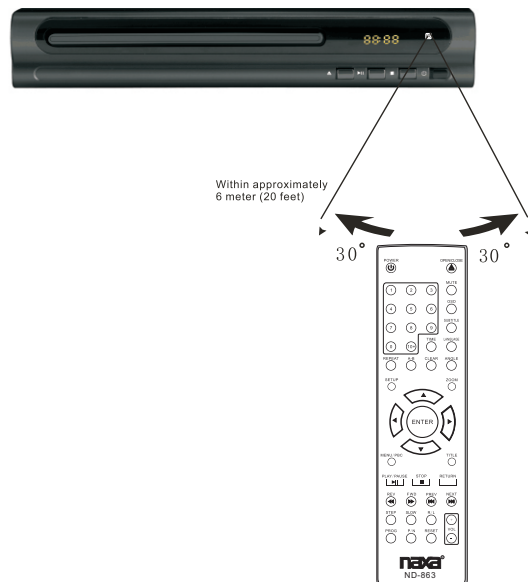
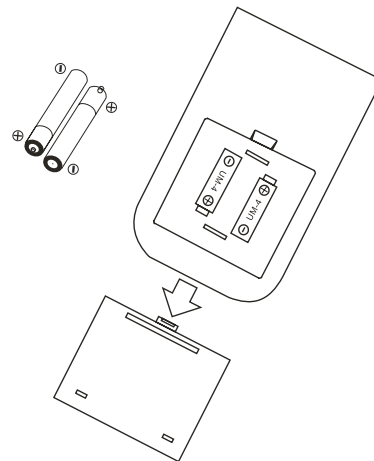

## ***BE ENVIRONMENTALLY FRIENDLY***

Do not dispose of batteries as normal rubbish. Be environmentally friendly, dispose of batteries following the Government's regulation.

## About DVD

DVD (Digital Versatile Disc) is a digital video medium under the MPEG II format, featuring a variety of revolutionary entertainment capabilities. The MPEG II video compression technology provides capacity for an excellent picture of minimum 500 lines resolution on screen, up to 8 language soundtracks, up to 9 views from different camera angles and up to 32 language subtitles (provided the DVD disc itself supports these features).

### Disc information

Disc types	DVD	CD
Format	DVD+R, DVD-R, DVD+RW, DVD-RW, DVD-9	CD-R, CD-RW
Recording Method	Digital / MPEG II	Digital
Capacity	Single-layer / Single side 4.7GB = 2 hr Single-layer / Double sides 8.5GB = 4 hr Double-layers / Single side 9.4GB = 4.5 hr Double-layers / Double sides 17GB = 8 hr	650MB=74min
Disc size	12cm / 8cm	12cm / 8cm
Horizontal Resolution	500 lines up	-
Sub-titles	32	-
Sound tracks	8	1

### REMARK

Some features contained in this DVD player are related to the DVD disc's software.

Some features cannot be performed if the disc does not support the feature, or requires special settings.

Check the features printed on the disc's packing or follow the instructions of the Disc's on screen menu.

### Select a DVD disc

#### DVD Region Code

DVD discs and DVD players are manufactured under the worldwide agreed DVD Regional Code System that the player will operate only with corresponding disc of the same Regional Code.

Region code	Region
1	Canada, USA
2	Europe (incl. Poland, Romania, The Czech republic), Japan, Middle East (incl. Saudi Arabia, Egypt, Iran, South Africa)
3	East Asia (incl. Hong Kong, Taiwan, South Korea), South-East Asia
4	Australia, Caribbean, Central & South America, Mexico, New Zealand
5	Africa, Former Soviet Union, India, North Korea, Pakistan, Turkmenistan
6	China

### Care of disc

Video disc contains high-density compressed data that needs proper handling

- Hold the disc with fingers. Hold the disc's outer edge and/or the center spindle hole. Do not touch the disc surface.

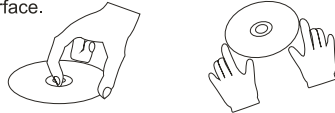

- Do not bend or press the disc. Do NOT expose the disc to direct sunlight or heating sources.



- Store discs in cabinet vertically, in dry condition. Prevent exposure to:
  - Direct sunlight
  - Heat or exhaust from a heating device.
  - Extreme humidity
- Clean the disc surface with a soft, dry cleaning cloth. Wipe the disc surface gently, radially, from center toward the outer edge.
- Do not apply thinner, alcohol chemical solvent, or sprays when cleaning. Such cleaning fluids will permanently damage the disc surface.

## About the player

### Front panel



- ① OPEN/CLOSE
- ② PLAY/PAUSE
- ③ STOP
- ④ POWER ON/OFF

### Back panel

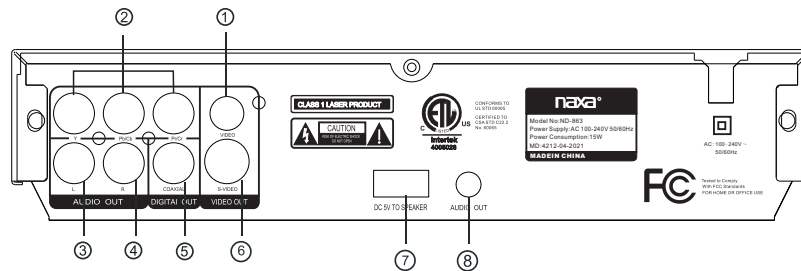

- ① VIDEO output jack
- ② Y/Pb/Pr output jack
- ③ Left channel output jack
- ④ Right channel output jack
- ⑤ Digital signal COAXIAL output jack
- ⑥ S-Video output jack
- ⑦ DC 5V To Speaker
- ⑧ Audio output



## Remote control

Some features of the player can only be performed by the remote control.

Some features described in this owner's manual are related to the Disc's encoding.

Some features may not be available, if the disc encoding does not support the feature.

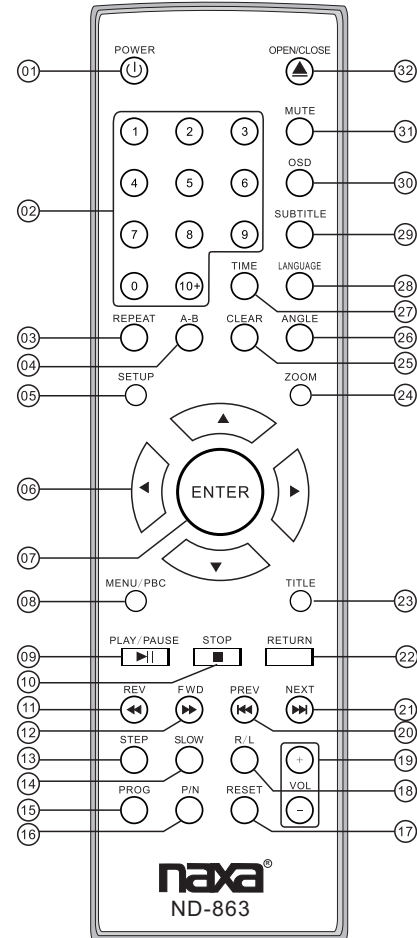

## REMARK

Some features contained in this DVD player are related to the DVD Disc's software. Some features cannot be performed if the disc does not support the feature, or requires special settings. Check the features printed on the disc's packing or follow the instructions of the Disc's on screen menu.

1. POWER
2. Numerics button (0-9,10+)
3. REPEAT
4. A-B
5. SETUP
6. UP/DOWN ARROW KEY  
LEFT/RIGHT ARROW KEY
7. ENTER
8. MENU/PBC
9. PLAY/PAUSE
10. STOP
11. REV
12. FWD
13. STEP
14. SLOW
15. PROG
16. P/N
17. RESET
18. R/L
19. VOL+/VOL-
20. PREV
21. NEXT
22. RETURN
23. TITLE
24. ZOOM
25. CLEAR
26. ANGLE
27. TIME
28. LANGUAGE
29. SUBTITLE
30. OSD
31. MUTE
32. OPEN/CLOSE

## Notes

The remote control transmits a directional infrared beam. Be sure to aim the remote control directly at the infrared sensor during operation. When the sensor is covered or there is a large object between the remote control and the sensor, the sensor cannot receive signals. The sensor may not be able to receive signals properly when it is exposed to direct sunlight or a strong artificial light (such as a fluorescent or strobe light). In this case, change the direction of the light or reposition the unit to avoid direct lighting.

# SYSTEM CONNECTION

## Preparations

### Accessories

1. Remote control
2. Audio/Video cable
3. User's manual
4. 2XAAA Size Battery

(check whether be fully equipped after open the box)

### Battery installation of remote controller

Place two AAA batteries into the battery compartment. Be sure the polarities are correct. There should be no large obstacles between the remote controller and the main unit.

### System connection(Optional according to your back panel)

1. When making connection between this unit and other components, be sure all connection with power-off.
2. Audio/Video cables are connected according to the different colour identification and they should be fitted firmly.
  - Yellow to video terminal
  - White to audio terminal L,
  - Red to audio terminal R,
3. Scheme of connection

#### ● 2.1 CHANNEL CONNECTION

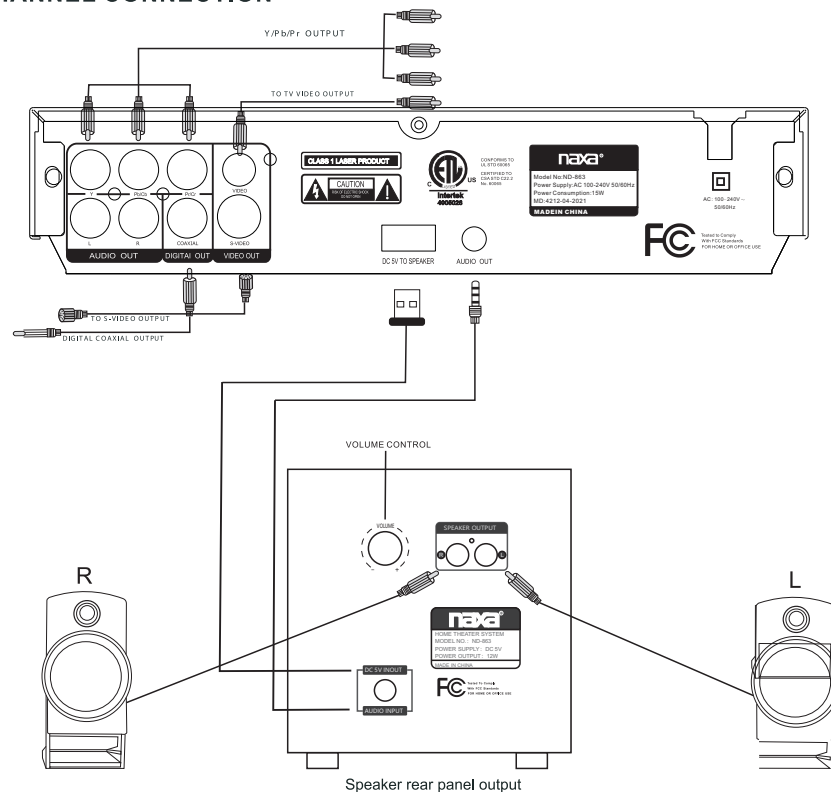

# GETTING STARTED

- Unpack the unit.
- Read through this owner's manual before installation and use.
- Load batteries into the remote control unit.
- Connect the system, make sure the connections are secured.
- Connect the power plug to the AC power outlet.

## REMARK

Some features contained in this DVD player are related to the DVD disc's software. Some features cannot be performed if the disc does not support the feature, or requires special settings.

Check the features printed on the disc's packing or follow the instructions of the Disc's on screen menu.

## Play a disc

### Switch on the player

Push the main power button to turn on the DVD unit. Power on the TV set and the amplifier if connected.

### Load a disc

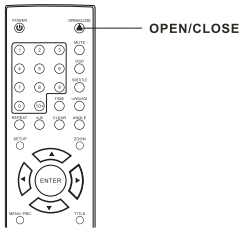

Press OPEN/CLOSE button on the remote control (or front panel) to open the disc tray. Load a disc and press OPEN/CLOSE to close the disc tray  
(Note, place the disc's label side up, blank side down)

### Automatic Play

The unit will take a few seconds to download the disc initial data, display the disc type logo in the left upper corner of the TV screen, and then start playing automatically.

### If a DVD Disc Menu appears on screen

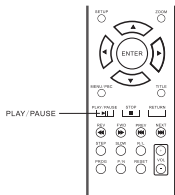

Press PLAY button on the remote (or on the unit) to start playing.

or

Press UP/DOWN buttons to select the desired feature in the menu,

And then press the ENTER button to confirm a selection.

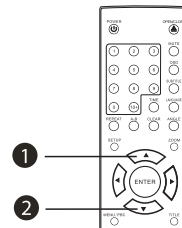

**NOTE** Normally, when a MP3 disc is loaded, the unit will take longer time to download the initial data. DVD disc that does not match the region code cannot be executed by this player.

Return to the disc main menu, press MENU button on the remote.

Prevent loading the disc upside down.

## Screen saver

The player is equipped with an automatic screen saver, for the purpose of protecting the TV screen.

The TV screen will be black and a screen Saver  will appear on screen if :

- No disc is loaded for 300 seconds
- In STOP mode and no button has been Pressed for 300 seconds.  
(except in the player or disc menu)

When any button is pressed, the player will resume to normal active mode.

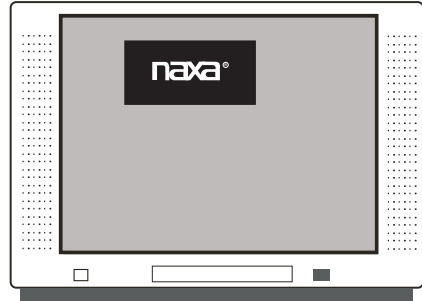

# FUNCTION BUTTONS

## Power ON / OFF



POWER ON /OFF

To switch the player Between power on and off mode:

Press POWER button on front panel

(Always switch off the player after use)

## Open /Close disc tray

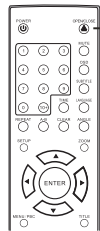

OPEN/CLOSE

To open and close The disc tray:

Press OPEN/CLOSE button  on the remote

## Play / Pause / Stop

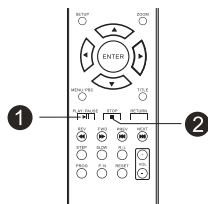

- ① Press PLAY button 

To play the Disc

Then Press PAUSE button 

Press  to resume normal playback.

- ② Press STOP button

to stop in two modes:

- a) Press Once : STOP memorizes the interrupt position.  
( May resume from the interrupt position with Play button  )
- b) Press Twice : To stop completely  
( May resume from the beginning with Play button )

## PREV/NEXT

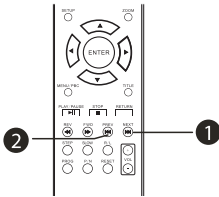

- 1 Press NEXT  for next track.
- 2 Press PREV  for previous track.

Player will not advance or reverse during "WARNING" section of any disc.

## Forward / Backward

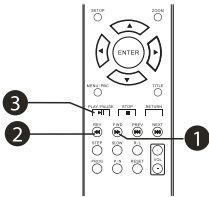

- 1 Press  to Search forward  
Repeat pressing the button to change search speed



- 2 Press  to search backward  
Repeat pressing the Button to change search speed



- 3 Press PLAY button  to resume normal playback

Player will not advance or reverse during "WARNING" section of any Disc.

The unit mode

## Slow Forward

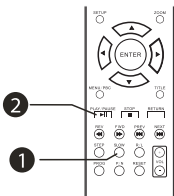

- 1 Press <sup>SLOW</sup> to play slow forward  
Repeat pressing the Button to change slow forward speed

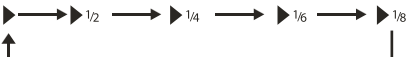

- 2 Press PLAY button  to resume normal playback

The unit muted in SLOW mode

## Select an item in menu

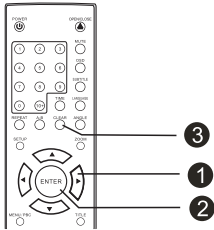

In the disc menu or setup menu

- 1 press cursor button to move between function items.
- 2 Press **ENTER** to confirm a selection.
- 3 Press **CLEAR** to cancel an entry.

## Disc Title /Menu

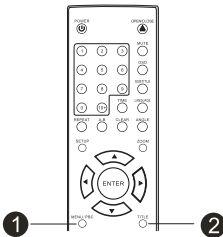

- 1 Press **MENU** button return to the DVD disc Menu.
- 2 Press **TITLE** Button return to the DVD disc Title.

**Disc MENU** Disc menu is a DVD disc feature, allowing users to select functions on screen.

**Disc TITLE** Disc title is the beginning track of a DVD disc. Some DVD discs refuse the "TITLE" function.

## Clear

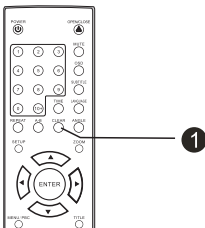

- 1 Setting program or searching need to input number. press **CLEAR** button to clear the number when the input number is wrong.

## Multi-Angle

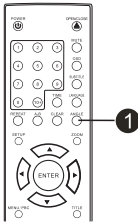

If a DVD disc contains Multi-Angle feature, viewing angles may be selected:

- 1 During in playback, repeat pressing ANGLE button  to select the desired viewing angle. Status will be displayed on screen..

A DVD disc may contain up to 9 selectable viewing angles.



## Multi-Subtitle

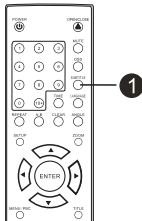

If a DVD disc contains the Multi-Subtitle feature, subtitle may be selected:

- 1 During in playback, repeat pressing SUBTITLE button  to select the desired subtitle. Status will be displayed on screen.

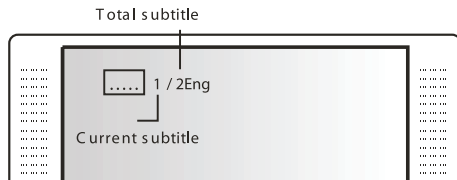

### NOTE

A DVD disc may contain up to 32 subtitle selections.

- A-B function does not apply to MP3 disc.
- The period between A and B should be at least 3 seconds



## Multi-Audio Soundtrack

If a DVD disc contains Multi-Audio Soundtrack feature, Audio Language can be selected:

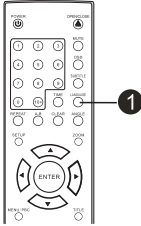

- 1 During in playback, repeat pressing LANGUAGE button  to select the desired audio language. Playback status will be displayed on screen.

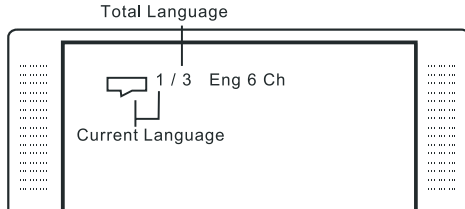

### NOTE

A DVD disc may contain up to 8 audio language selections.

In most cases, an Audio Soundtrack selection will be displayed on a DVD disc start up menu.

Press CURSOR Button to select and ENTER button to confirm.

## Number Keys

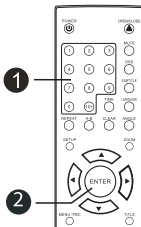

- 1 These keys are used to input the time, as well as title, chapter and track numbers.  
When a CD, DVD, MP3 or VCD is playing (with PBC off), press the 0-9 keys to select a track directly, then press ENTER to confirm.
- 2 When a numeric item is displayed on the screen, Press the 0-9 keys to select the desired entry, and press ENTER to confirm.

## SEARCH a desired section



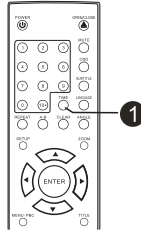

This function does NOT apply to MP3

- 1 Press the **TIME**  button to play at a desired Title, Chapter or Time.



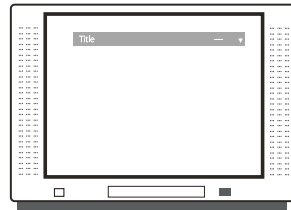

### DVD disc

- Press the **TIME**  button select SEARCH Mode.
- Press **DOWN**  button highlight desired item.
- TITLE** ---      Input title number  
**CHAPTER** ---      Input chapter number  
**TIME** --:--:--      Input time hh:mm:ss  
 (Hour : Minute : Second)
- Press **ENTER**  button.



### CD disc

- Press the **TIME**  button to T rack Search mode.
- Press **DOWN**  button highlight desired item.
- TIME** --:--:--      Input time hh:mm:ss  
 (Hour : Minute : Second)
- Disc Time** ---      Input Disc Time hh:mm:ss  
 (Hour:Minute:Second)
- Press **ENTER**  button.

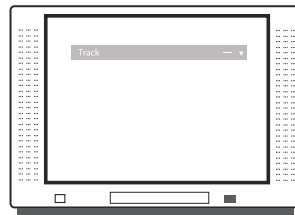

### NOTE

- SEARCH functionality depends on different DVD disc's format. Some DVD discs do not allow SEARCH function.
- SEARCH does NOT function during Program playback.

## Repeat

- 1 Press REPEAT  button multiple times to reach desired repeat mode (see below).

### DVD disc

Repeat Chapter	Repeat the Chapter
Repeat Title	Repeat the Title
Repeat Off	Repeat function off

### CD disc

Repeat Single	Repeat the existing track
Repeat All	Repeat all tracks
Repeat Off	Repeat function off

### MP3 disc

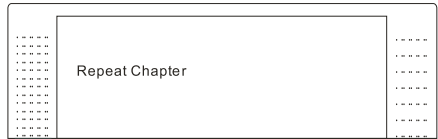
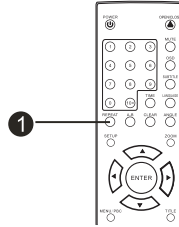

Repeat Single	Repeat the existing track
Repeat Folder	Repeat all tracks
Repeat Off	Repeat function off



### NOTE

Repeat functionality depends on different disc's production format, some DVD discs do not allow repeat function.

## Repeat the section A-B

- 1 To repeat playback of a desired section:
- 1) Press the A-B  button at the beginning of the desired section, "A".
  - 2) Press the A-B  button again at the end of the desired section, "B".

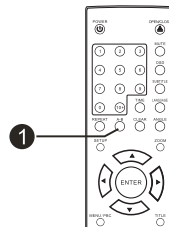
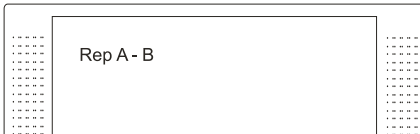

The player will repeat playback of the section from A to B.

Press the A-B  button again to cancel the function and return to normal play.

### NOTE

- A-B repeat depends on different disc's production format, some DVD discs do not allow repeat function.

## ZOOM

### In DVD mode

- 1 Press the **ZOOM**  Button to enlarge viewable picture.

Press the button repeatedly to change the zoom scale:



- 2 Press the **CURSOR** buttons to adjust the zooming position.

Enlarged scale

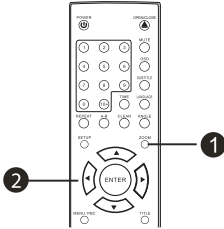
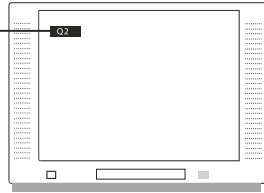

### NOTE

The picture quality is degraded as the picture is increased.

## Mute

- 1 Press **MUTE**  button To mute ( turn off ) the audio output.

Press the button again  
To resume normal audio output.

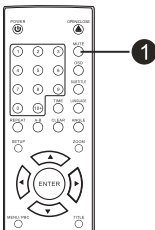

## PBC Play

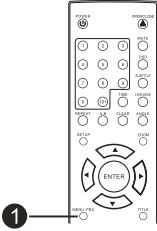

- 1 For VCD2.0 disc playing in the condition of PBC ON, Song selection can only be done, when the playing returned to main menu in the condition of PBC OFF, press relevant number Key to get favorite song during playing

## R/L

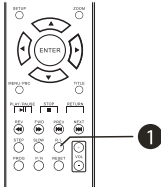

- 1 When play VCD CD disc press, **R/L** Key to select left vocal, Right vocal Mix, Stereo vocal

## Program setting

Program to play a DVD, CD and MP3 disc in a desired sequence automatically

### DVD/VCD program menu

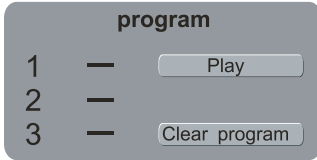

Load a DVD or VCD disc.

1. Press the PROG button, the program menu will appear.
2. Use the left key to move the cursor to the left side, put the number of the title/chapter which you want to program, then press right button to move to "play", then press "enter" to confirm.
3. If you want to cancel the program, press right and down button to move to "clear program", then press "enter" to confirm.
4. If you want to exit, just press "PROG" button again.



### CD/MP3 program menu

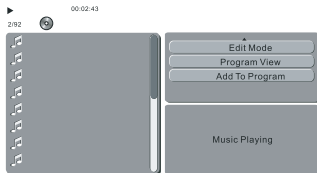

Program CD orMP3 disc.

1. CD and Mp3 play back menu will appear immediately once you put your CD in the player.
2. Press the right button to move to the play back menu.
3. Press the down button to scroll down to highlight "EDIT MODE" and press enter.
4. Press the left button to move back to the tracks and select desired tracks you want to listen to and press enter.
5. Go back to play back menu and scroll down and highlight "ADD TO PROGRAM" and press enter.
6. Scroll up and highlight "PROGRAM VIEW" and press enter so you can view the program tracks.
7. Press play to start playing.
8. Press "STOP" button twice to stop the playing, then, press the left button to move back to the tracks and select desired tracks you want to clear and press enter, and then, press the right button to select "Clear Program" or turn the unit off to clear program.

#### NOTE

- Some DVD discs do not allow programming.
- Single track disc cannot be programmed.

## Return

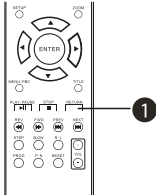

- 1 In PBC mode , when pressing "RETURN"Key to <sup>RETURN</sup> return to the menu, thus canceling the PBCmode , the "RETURN" key will be invalid

## P/N

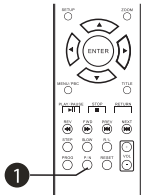

- 1 Press <sup>P/N</sup> when in STOP mode to select the mode from NTSC/PAL/AUTO.

# ON SCREEN DISPLAY

## DISPLAY

Press  button an On Screen Display indicator will be displayed at the upper part of the TV screen in displaying the disc information and operation status.

The Display indicator will remain on screen until pressing the Display button to turn it off.

The Display indicator is a user friendly interface designed for displaying the status of the playback. When a different disc is loaded (DVD, CD or MP3), the Display indicator will be different.

## DISPLAY- DVD mode

Press DISPLAY button once to display as follows:



Playback time/Track remain time

Press DISPLAY button twice times to display as follows:



Disc Title  
current title / total disc titles

Chapter  
current chapter / total chapters

The three times press DISPLAY button to display as follows:

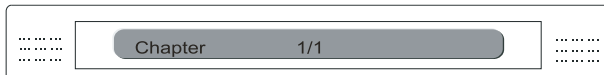

The four times press DISPLAY button to display as follows:



Audio Sound Track  
current audio / total tracks

Audio format  
• 2Ch  
• LPCM LPCM

The five times press DISPLAY button to display as follows:

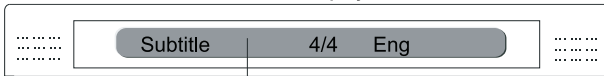

Disc Subtitle  
current subtitle / total disc subtitles

The six times press DISPLAY button to display as follows:

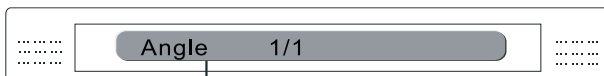

Multi-angle  
Current angle / Total angles



# ON SCREEN DISPLAY

**MP3 mode**

**Playback time**

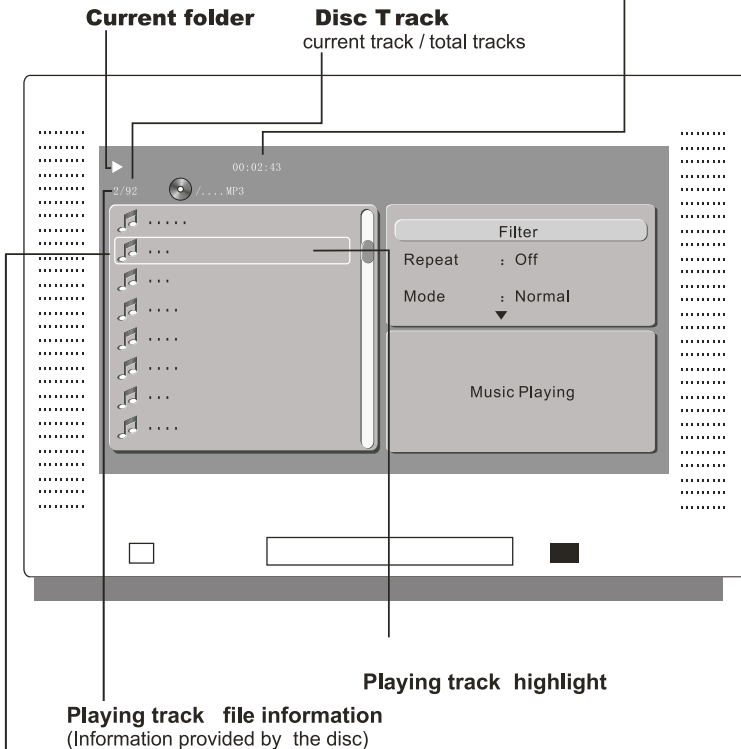

**Selection highlight**  
(Press ENTER  button to play this track)

**Select a track**  
Press MOVE UP/DOWN button to highlight the desired track, and switch between folder and pages.  
Press ENTER  button to play the selected track.

**Playing track file information**  
You may add the information of the MP3 file while you create the disc, e.g. artist, song name and date etc., Those information of the playing track will be display at the lower part of the screen.

# SETUP

Various features of the player can be adjusted in the SETUP menu:

Press **SETUP**  button  
SETUP menu appears.

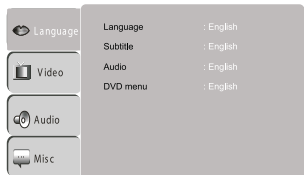

Highlight the desired icon Press **RIGHT** button to activate the setting sub menu.

## Language

Enter this menu to setup the language in OSD display, DVD disc subtitle, DVD disc audio and DVD disc start menu.

Press **SETUP**  button

Highlight "Language",  
Press **RIGHT** , Language sub menu appears.

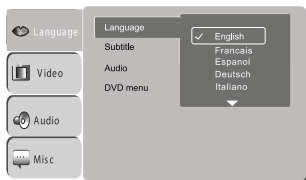

Highlight the desired item and press **ENTER** button,

Highlight the desired item,

Press **RIGHT** button to confirm.

Press **SETUP**  button to save the setting and quit.

## Video

Enter this menu to setup the video setting

Press **SETUP**  button

Highlight "Video",

Press **RIGHT** ,Video sub menu appears.

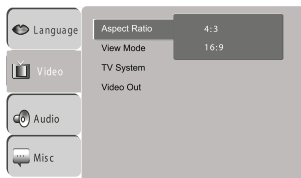

Highlight the desired item and press **ENTER** button,

Highlight the desired item,

Press **RIGHT** , button to confirm.

Press **SETUP**  button to save the setting and quit.

## TV screen

The aspect ratio of the picture provided by the DVD player can be varied in line with the features available on the TV in use.

### 4:3 Letter

Allow you to see movies in their original aspect ratio. Entire frame of the movie will be display on screen, but it will occupy a smaller portion of the screen.



# SETUP MENU (Press SETUP button)

## 16:9 Wide Scr

When you connect to a wide screen TV, this setting will allow the original aspect ratio will be display full screen.



### NOTE



Depending on the DVD disc format, e.g. 2.35:1, the wide screen setting may still having black margins above and below the picture.

## TV System

TV System menu is to set up the broadcast system:

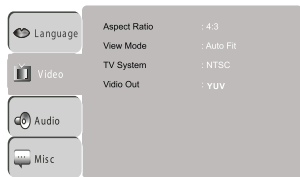

**AUTO** Auto switch to NTSC system according to the disc, if not, the default system is NTSC  
**NTSC** NTSC TV system

## Audio (digital audio)

Enter this menu to setup the digital audio output format of different signal type. The selectable output formats are PCM, All or Off

Press **SETUP** Button

Highlight "Audio",

Press **RIGHT**, Audio sub menu appears.

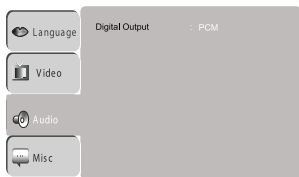

## Misc

1. Using the UP/DOWN direction buttons, move to the Rating. The player's Rating settings will appear.

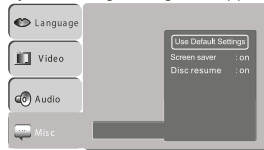

2. Use the **RIGHT** direction buttons to skip to select the setting.
3. Use the UP/DOWN direction to change the setting.
4. Press **OK** for each setting to cycle through the options and change the settings.

The following subsections explain the available options for each of the player's Misc setting.

Use Default Settings:

Press **OK**, pop up window "Use Default Setting",

There are two selections: YES/NO.

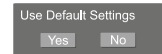

No=Return to Use Default Setting  
Yes=Close Setup menu, play disc.

# TROUBLE SHOOTING

Should your DVD player develop a problem, please check below before requesting service:

Symptom	Check and Action
No Power	<ul style="list-style-type: none"> <li>• Check if the power cord has been properly connected to the power outlet.</li> <li>• Check if the main power has been switched on.</li> </ul>
Does not play	<ul style="list-style-type: none"> <li>• No disc, load a disc.</li> <li>• Disc has been loaded upside down. Place the disc with the label side up.</li> <li>• Disc's region code does not match to the player.</li> <li>• Disc is not correct type for player.</li> <li>• Disc is damaged or dirty, clean the disc or try another disc.</li> <li>• Moisture may be condensed inside the player. Remove the disc and leave the unit power on for one or two hours.</li> </ul>
No Picture	<ul style="list-style-type: none"> <li>• Check if the TV set has power on, use TV remote to select A/V signal for DVD rather than broadcast.</li> <li>• Check if the system connection is proper and secure.</li> <li>• Check if the connection cables are damaged.</li> <li>• Clean the disc.</li> </ul>
Picture noise / distorted	<ul style="list-style-type: none"> <li>• The disc is dirty or damaged. Clean the disc or try another disc.</li> <li>• Reset the color system of the player or the TV set.</li> <li>• Try to direct the player to the TV set instead of via other components, such as a VCR.</li> </ul>
Picture not full screen	<ul style="list-style-type: none"> <li>• Select the screen format from the player's SETUP MENU, see "SETUP MENU " of this manual.</li> <li>• <b>Select the screen format from DVD disc menu.</b></li> </ul>
Malfunction	<ul style="list-style-type: none"> <li>• Should the player develop a malfunction, unplug the player for 30 minutes. After 30 minutes, power on the player and the restore function should reset the player.</li> </ul>
No sound	<ul style="list-style-type: none"> <li>• DTS disc used. Press the remote control "LANGUAGE" button  and re-select the audio setting on the remote.</li> </ul>



**CAUTION** : To reduce the risk of fire and electric shock, do not remove the cover (or back) of the unit. Refer servicing only to Singer Service Technician

Symptom	Check and Action
Cannot SKIP or SEARCH	<ul style="list-style-type: none"> <li>Some discs are programmed that do not allow users to SKIP or SEARCH at some sections, especially at the beginning WARNING section.</li> <li>Single Chapter disc cannot apply SKIP function.</li> </ul>
No sound or sound output not complete	<ul style="list-style-type: none"> <li>Check if the TV and Amplifier have been switched on, and correctly set.</li> <li>Check if the TV and Amplifier system connection is secured.</li> <li>Press LANGUAGE button to select other audio tracks output of disc.</li> <li>Check if the MUTE function of the TV or Amplifier has been activated.</li> <li>There will be no sound output during P AUSE / STEP / SLOW and SEARCH.</li> </ul>
No surround sound	<ul style="list-style-type: none"> <li>If digital output has been applied: <ul style="list-style-type: none"> <li>Press SETUP button</li> <li>Highlight "AUDIO"</li> <li>Highlight "Digital Out"</li> <li>Select RAW or PCM</li> <li>Press SETUP button</li> </ul> </li> <li>Power on the amplifier or active type loudspeakers.</li> </ul>
MP3 disc no sound or noisy	<ul style="list-style-type: none"> <li>When PC program files or other data files are mixed with MP3 files in the same disc, the player may play the non-MP3 files with noise or no sound.</li> <li>Check the disc, if all the files on disc are MP3 files Skip the file, try other files.</li> </ul>
Remote control does not function	<ul style="list-style-type: none"> <li>Remove the obstacles between the remote control and the player .</li> <li>Point the remote control towards the remote sensor on the player.</li> <li>Check if the batteries of the remote control have been loaded with correct polarities.</li> <li>Replace the batteries of the remote control.</li> </ul>

# SPECIFICATIONS

Type of Disc	DVD CD-DA CD-MP3 Kodak Picture CD CD-R / CD-RW
Video Format	MPEG 2
Audio Format	MPEG 1, LAYER 1, LAYER 2, LAYER 3
Signal Output	Color System: NTSC Audio System: DIGITAL down mix stereo DIGITAL digital output Audio DAC 16bit/48KHz  Video Output: 1 Vpp (at 75 ohm) Audio Output (Stereo): 2 Vpp
Frequency Response	CD: 4Hz 20KHz (EIAJ) DVD: 4Hz 22KHz (48K) 4Hz 44KHz (96K)
S/N ratio	> 92 dB
THD	< 0.04%
Output Terminals	Video (composite) output X1 S-Video output X1 YPbPr output X1 Coaxial output X1
Power Supply	AC 100-240V~ 50/60Hz
Dimensions	DVD size : W225xD215xH58mm