

naxa[®]

40" WIDE SCREEN HD LED TV

MODEL NO.: NT-4001



Instruction Manual

PLEASE READ CAREFULLY BEFORE USE

USER'S MANUAL

Safety Information

Warning

To prevent fire and/or electric shock, do not use this plug with an extension cord, receptacle or other outlet unless the blades can be fully inserted to prevent blade exposure. Do not expose this appliance to rain or moisture.

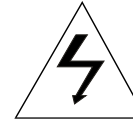

CAUTION !

**RISK OF ELECTRIC SHOCK
DO NOT OPEN**



AVIS

RISQUE DE CHOC ELECTRIQUE/NE PAS OUVRIR

Important Safety Instructions

Read these instructions.

Keep these instructions.

Heed all warnings.

Follow all instructions.

Please, unplug the TV power cord when the following conditions occur:

-When there is a thunderstorm (Please, pull out the power cord and antenna).

-When cleaning the TV set.

-When the TV set is not used for a long time.

Do not use corrosive deparative when cleaning the TV set.

Do not put the TV set under direct sunlight or near heat.

Do not put a heat source, such as a candle or heater, on top of or near the TV set.

Leave plenty of space (at least 10cm) around the TV set for ventilation.

Place the TV set away from where it can be ruined by rain or water (such as near a window).

Don't put a container with liquid (such as a vase) on top of the TV set.

Do not move the TV set when the power is on.

Do not touch, push or scratch the surface of the TV set with hard materials or items.

When TV surfaces are dirty, please use a wet cotton cloth or soft cloth with non-corrosive cleaners to clean it carefully. Don't use acetone, toluene or alcohol to clean the TV set.

Be aware and careful of moisture, which can damage inner electronic components.

When condensed moisture is present, the TV screen may appear blurry or spotty.

It is recommended that a technician install the TV set on a wall, if such placement is desired.

An incorrect wall installation will be unsafe and hazardous.

Do not let children climb on or play around the TV set to avoid falls, collisions, damages and injuries.

Do not hit the TV panel with hard objects to prevent damages.

Do not cover the TV set with blankets or other objects when it is connected to a power source to prevent overheating and fire.

Batteries shall not be exposed to excessive heat such as sunshine, fire or the like.

Mains plug is used as disconnect device from the mains, the disconnect device shall remain readily operate.

Apparatus with class I construction shall be connected to a mains socket outlet with a protective earthing connection.

Important Safety Precautions

Safety

Please immediately pull out the AC power plug if there is an abnormal sound or smell or the LED TV has sound but no picture, and contact after sales support.



The LED TV should be kept free from rain, moisture and dust to prevent electrical shock and short circuits. Do not cover the ventilation openings with table clothes, curtains, newspapers, etc.

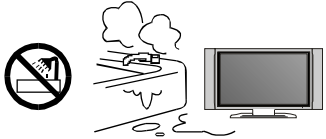

The LED TV should be kept from high temperature heating sources or direct sunlight. Good ventilation is required. Allow 10 cm. between the LED TV and other appliances or built-in cabinet walls.

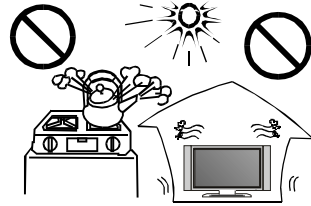

When you wipe the front cabinet, please make sure the power plug is pulled out and use a soft, dry, lint-free cloth and handle it with care. Do not repeatedly wipe the panel, nor scrape, tap or strike the panel with a hard object.

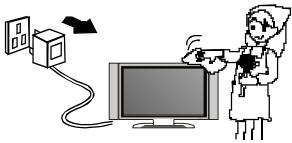

Do not wipe the LED TV with any petrol, chemical or alcohol based solvents as it will lead to product damage of the panel and cabinet.

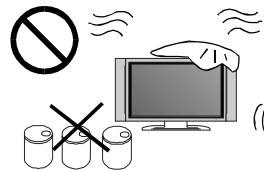

Important Safety Precautions

Safety

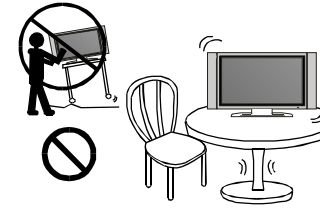

Do not place the LED TV on an unstable surface.

Do not place the power cord or other cables across a walkway in case it is trampled on. Do not overload the power cord or power socket. When the power plug is used to disconnect and connect the device, it should easily into the power source.

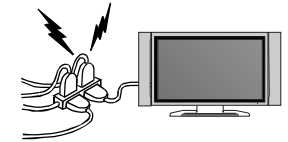

Do not disassemble the back cover, as it contains high voltages inside and will cause electric shock. Only qualified professionals should conduct internal adjustments, maintenance, and checks.

The TV set should not be subjected to water droplets, vapor, or splash. This equipment should not be placed on objects filled with liquids. Do not place flame sources, such as lit candles, on or near the LED TV. Please, pull out the power plug and contact after sales support if there are abnormal objects or water in the TV.

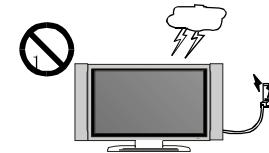
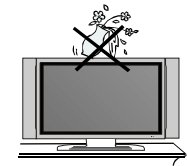

Pull out the power cord and antenna cable during electrical storms so the LED TV is not damaged by electrical surges. Keep all people away from the antenna cable during electrical storms.



ENERGY STAR® Qualification.

This product has earned the ENERGY STAR® for meeting U.S. Federal energy efficiency guidelines as set by the Department of Energy and Environmental protection agency.

The ENERGY STAR® program exists to provide energy saving guidelines and help promote energy efficient products and practices. Changes to certain features, settings and functions of this TV can change and/or increase its power consumption.

As-shipped mode is the mode in which the product qualifies for ENERGY STAR®.

Table of Contents

Introduction	
Features	2
Specifications	3
Accessories	4
General Description	4-7
Overview of front & back panel	4
Overview of back panel	5
Overview of remote control	6
Installing Batteries in the remote control	7
Antenna connection	7
External Connection	8-12
Connecting VCR	8
Connecting DVD Player/Set-Top Box	9
Connecting Digital Audio System	10
Connecting USB	11
Connecting DVD Player/Set-Top Box via HDMI	12
Connecting PC	13
Connecting a Headphone	14
Supporting signals	14
Basic operation	15
Turning the TV On and Off	15
OSD Menu Operations	16-23
INPUT SOURCE SELECTION	16
BASIC OPERATION	16
FIRST TIME INSTALLATION	16
PICTURE	17
SOUND	18
TIME	19
SETUP	19-20
LOCK	21
CHANNEL	22
PC SETTINGS	23
USB Operation	23-24
Troubleshooting	25
Picture defects and the reason	26

Introduction

Features

- TV adopts TFT LED display screen
- HDTV Compatible(480p, 480i, 720p, 1080i, 1080p)
- Support American TV Standard 8VSB/Free 64/256QAM,NTSC System, ATSC System
- Connect to computer directly to realize TV/monitor combo.
- Zero X radiation complies to green environment protection requirement
- Advanced Chroma Processing
- Closed captioning/Program Control
- SAP/STEREO/MONO; ATSC.
- HDMI input
- USB input

Input terminals used for external equipment connection

One computer VGA/PC input	One PC Audio input
One AV input	One HDMI in put
One EARPHONE output	One USB input
One ANTENNA input	One Coaxial output
One YPbPr input	

Introduction

Specifications

Display screen type	Color active matrix LED display
Model	NT-4001
The maximum resolution	1920×1080
Image control	Fine digital control
Power supply	AC 100-240V, 50/60Hz
TV receive system	NTSC System, ATSC System
Frequency range	Antenna: 2~69; Cable: 2~125
Antenna input impedance	75Ω (Unbalance)
Sound output	2×8W
Power supply for remote controller	DC 3V (Two AAA size batteries)
Power consumption	80 W
Dimensions (L×W×H)	36.5×8.7×23.2 inch
Weight (Net weight)	7 kg
Operation environment temperature	0°C-40°C

Note:

Design and specification modification maybe made at any time without prior notice; all data and dimensions are approximations.

Accessories

Please make sure the following items are included with your LED TV. If any items are missing, contact your dealer.



Remote Control & Batteries (AAAx 2)

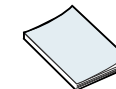

Owner's Instructions

General Description

Overview of front & back panel

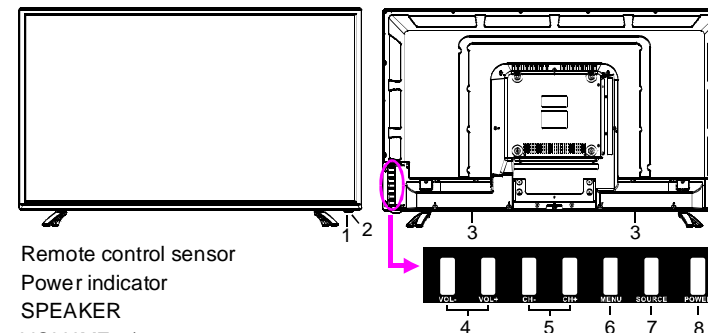

1. Remote control sensor
2. Power indicator
3. SPEAKER
4. VOLUME +/-
Press to increase/decrease the volume.
In the on-screen menu, use them to move left/right.
5. CHANNEL +/-
Press to change channels.
In the on-screen menu, use them to move up/down.
6. MENU
Press to see an on-screen menu of your TV.
7. SOURCE
Toggles between all the available input sources
8. POWER
Press POWER button to toggle between normal and standby mode.

General Description

Overview of back panel

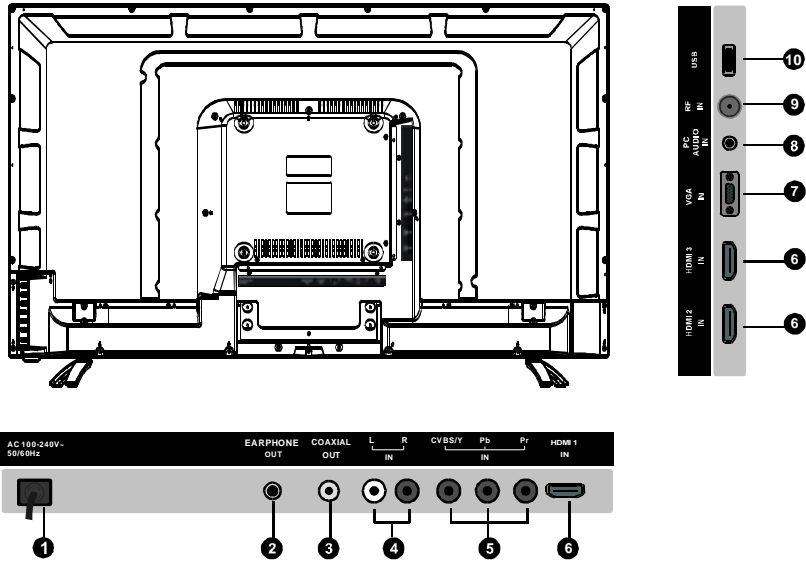

1. Power input
2. EARPHONE
Connect a set of phone for private listening.
3. COAXIAL
Connect to a Digital Audio device.
4. AUDIO L/R
Audio input for CVBS and YPbPr.
5. Y (CVBS) / Pb / Pr
Video input
6. HDMI
Connect to the HDMI jack of a device with a HDMI output.
7. VGA/PC IN
Connect to the video output jack on your PC.
8. PC AUDIO
Audio input for PC.
9. ANTENNA INPUT
Connect to an antenna or cable NTSC & ATSC.
10. USB

General Description

Overview of remote control

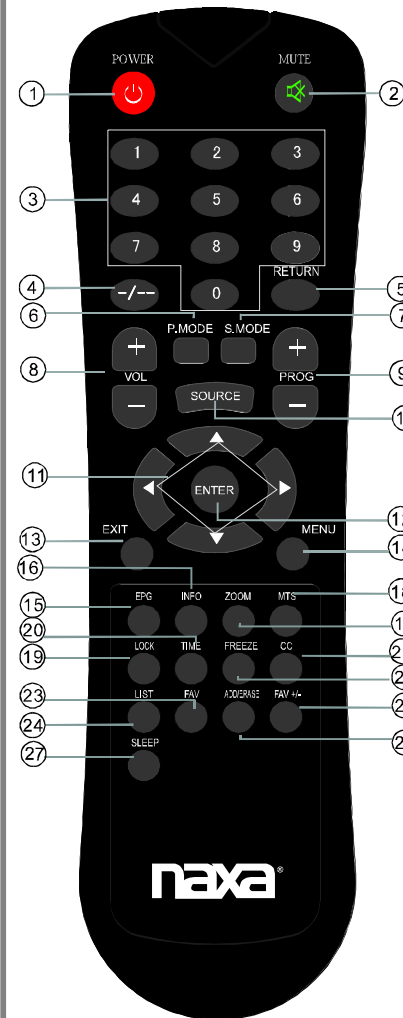

1. **POWER:** Switch a LED TV when at standby mode or vice versa.
2. **MUTE:** Press to mute the sound. Press again or press VOL+ to unmute.
3. **Number key(0-9):** Press 0-9 to select a TV channel directly when you are watching TV. The channel change after 3 seconds.
4. **-/--:** Press this button to enter a program number for multiple program channel such as 2-1, etc.
5. **RETURN:** Return to the previous channel viewed.
6. **P.MODE:** Press repeatedly to cycle through the available video picture modes.
7. **S.MODE:** Press to cycle through the different sound settings.
8. **VOL +/-:** Press to increase/decrease the sound level.
9. **PROG +/-:** Press to scan through channels.
10. **SOURCE:** Press to change input source.
11. **ARROW BUTTONS (/ / /):** Use to move cursor up/down/left/right.
12. **ENTER:** Validation key.
13. **EXIT:** Press to exit all menu.
14. **MENU:** TV system setup.
15. **EPG:** Press to display the EPG menu.
16. **INFO:** Displays the channel information.
17. **ZOOM:** Press to change the screen scale.
18. **MTS:** Press to select the audio channels.
19. **LOCK:** Press to display the Lock menu.
20. **Time:** Press to display current time.
21. **CC:** Press to display the closed caption.
22. **FREEZE:** Press to freeze the screen.
23. **FAV:** Selects favorite channels.
24. **LIST:** Press to display the TV program list.
25. **FAV +/-:** Press this button +/- the favorite program list.
26. **ADD:** Add this program to the favorite channels list. **ERASE:** Delete this program from the favorite channels list.
27. **SLEEP:** Set the sleep timer.

General Description

Installing Batteries in the Remote Control

Installing Batteries

- 1 Open the battery compartment cover on the back side.

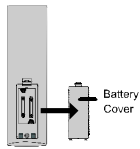

- 2 Insert two 1.5V AAA size batteries in correct polarity. Don't mix old or used batteries with new ones.

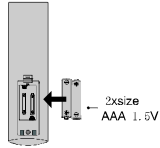

- 3 Closed the cover.

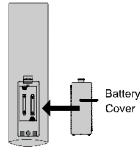

- † Point the remote towards the remote control sensor of the wireless TV and use it within 7 meters.

- † Put the used batteries into the recycling bin since it can negatively affect the environment.

Note:

- One loading of batteries will last for 1 year under normal use.
- If you do not intend to use the remote controller for a long period of time, remove them to avoid damage due to leakage.
- Do not use old and new batteries together.
- The batteries shall not be exposed to excessive heat such as sunshine fire of the like.

External Connection

Antenna connection

Antenna input impedance of this unit is 75ohm. VHF/UHF 75ohm coaxial cable can be connected to the antenna jack directly, if the antenna cable is 300ohm parallel flat feeder cable, you need to use the 300ohm/75ohm converter to connect the antenna cable to the antenna jack. For details Please refer to the following drawing.

Antennas with 30ohm flat twins Leads

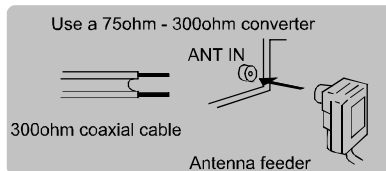

Antennas with 75ohm Round Leads

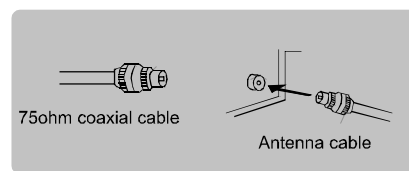

External Connection

Connecting VCR

These instructions assume that you have already connected your TV to an antenna or a cable TV system. Skip step 1 if you have not yet connected to an antenna or a cable system.

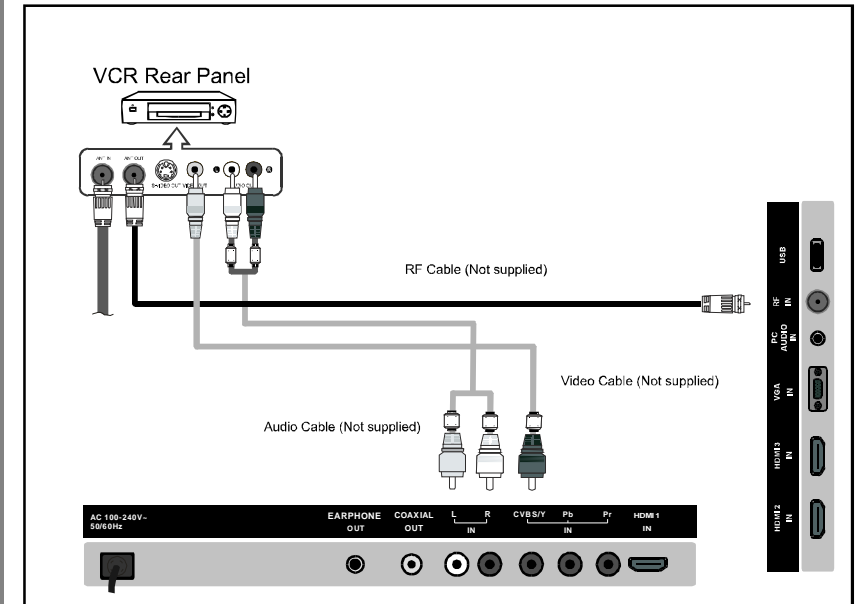

Follow the instructions in Viewing a VCR or Camcorder Tape to view your VCR tape.

Each VCR has a different back panel configuration.

When connecting a VCR, match the color of the connection terminal to the cable.

We recommend the use of cables with a Ferrite Core.

1. Unplug the cable or antenna from the back of the TV.
2. Connect the cable or antenna to the ANT IN terminal on the back of the VCR.
3. Connect an RF Cable between the ANT OUT terminal on the VCR and the ANT IN terminal on the TV.
4. Connect a Video Cable between the VIDEO OUT jack on the VCR and the VIDEO IN jack on the TV.
5. Connect Audio Cables between the AUDIO OUT jacks on the VCR and the AUDIO L and AUDIO R jacks on the TV.
 - If you have a mono (non-stereo) VCR, use a Y-connector (not supplied) to hook up to the right and left audio input jacks of the TV. If your VCR is stereo, you must connect two cables.

External Connection

Connecting DVD Player/Set-Top Box

The rear panel jacks on your TV make it easy to connect a DVD to your TV.

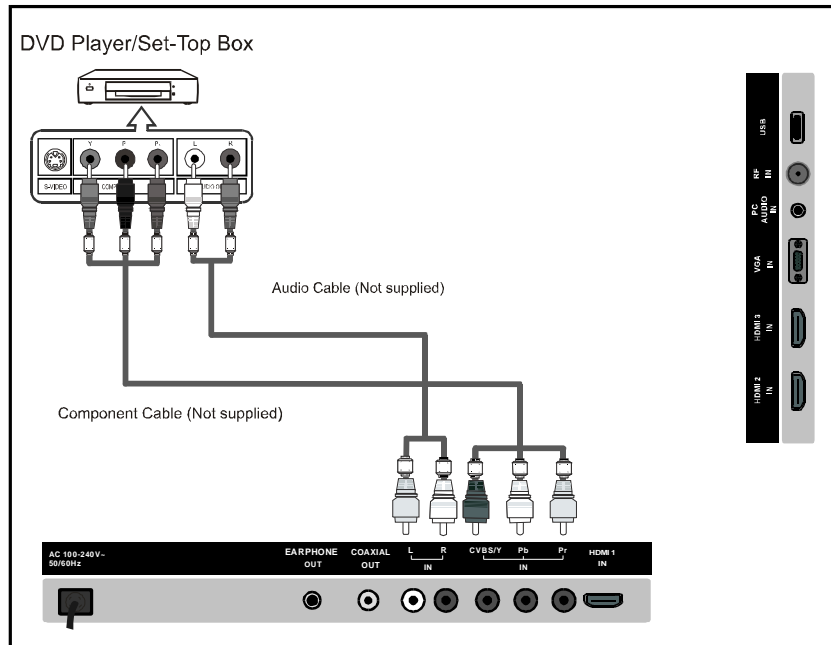

Component video separates the video into Y (Green), Pb (Blue) and Pr (Red) for enhanced video quality.

Be sure to match the component video and audio connections.

For example, if connecting the video cable to COMPONENT IN, connect the audio cable to COMPONENT IN also.

Each DVD player/STB has a different back panel configuration.

When connecting a DVD player/STB, match the color of the connection terminal to the cable.

We recommend the use of cables with a Ferrite Core.

1. Connect a Component Cable between the COMPONENT IN [Y, PB, PR] jacks on the TV and the COMPONENT [Y, PB, PR] jacks on the DVD player.
2. Connect Audio Cables between the COMPONENT IN [R-AUDIO-L] jacks on the TV and the AUDIO OUT jacks on the DVD player.

External Connection

Connecting Digital Audio System

The rear panel jacks on your TV make it easy to connect a Digital Audio System to your TV.

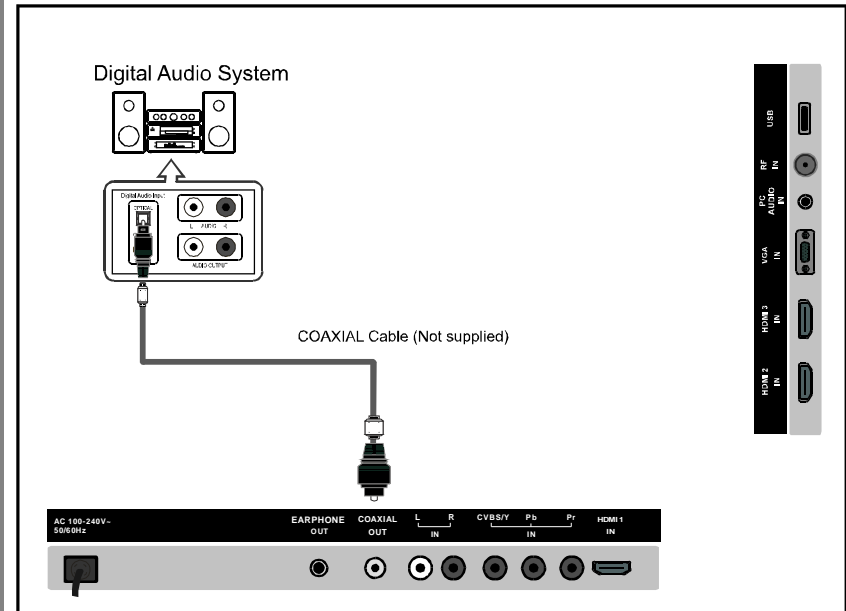

5.1 CH audio is possible when the TV is connected to an external device supporting 5.1 CH.

We recommend the use of cables with a Ferrite Core.

1. Connect a COAXIAL Cable between the SPDIF jacks on the TV and the Digital Audio System Input jacks on the Digital Audio System. When a Digital Audio System is connected to the SPDIF terminal: Decrease the gain (volume) of the TV, and adjust the volume level with the system's volume control.

External Connection

Connecting USB

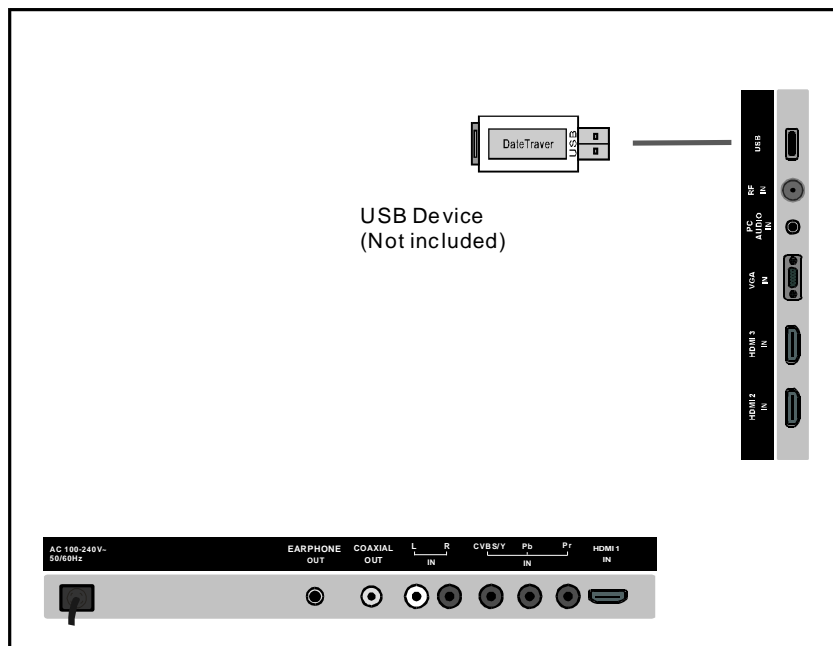

Connect a USB 2.0 memory device into USB slot of this TV for multimedia files playback.

1. This USB slot only supports Music and Photo multimedia files playback.
2. This TV is compatible with most USB devices in the market. However, we cannot guarantee the compatibility of all USB devices, due to multiple technology standards used.

External Connection

Connecting DVD Player/Set-Top Box via HDMI

This connection can only be made if there is a HDMI Output connector on the external device.

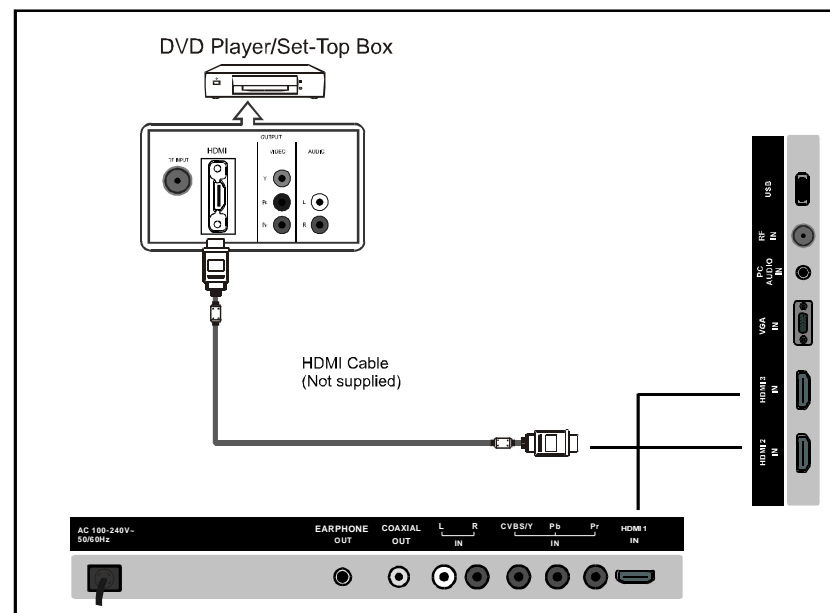

What is HDMI.

HDMI, or high-definition multimedia interface, is a next-generation interface that enables the transmission of digital audio and video signals using a single cable without compression.

Multimedia interface is a more accurate name for it especially because it allows multiple channels of digital audio (5.1 channels).

The difference between HDMI and DVI is that the HDMI device is smaller in size, has the HDCP(High Bandwidth Digital Copy Protection) coding feature installed, and supports multi-channel digital audio.

Each DVD player/STB has a different back panel configuration.

We recommend the use of cables with a Ferrite Core.

1. Connect an HDMI Cable between the HDMI connector on the TV and the HDMI connector on the DVD player/Set-Top Box.

External Connection

Connecting PC

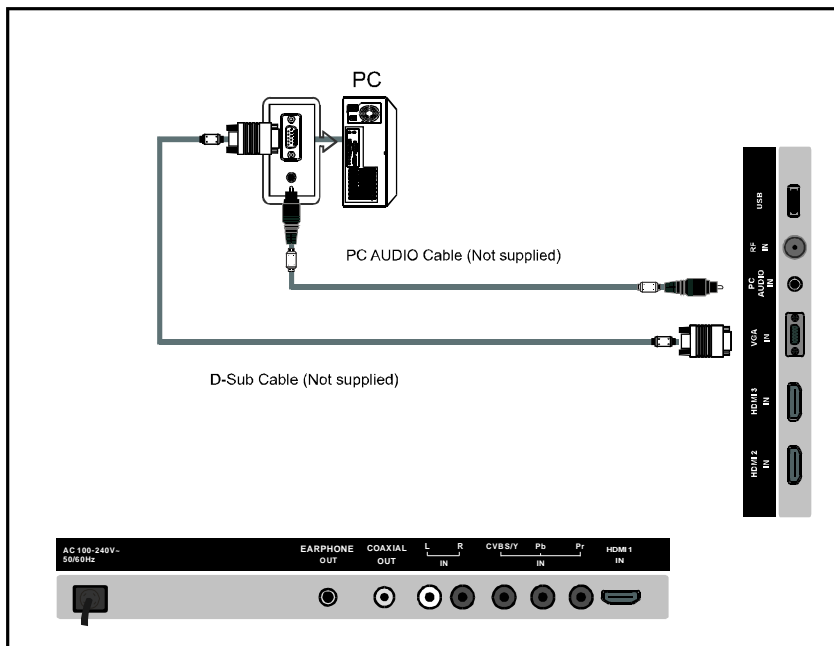

Each PC has a different back panel configuration.
The HDMI jacks do not support PC connection.
We recommend the use of cables with a Ferrite Core.

1. Connect a D-Sub Cable between RGB/PC IN connector on the TV and the PC output connector on your computer.
2. Connect the PC audio input jack on the TV.

External Connection

Connecting a Headphone

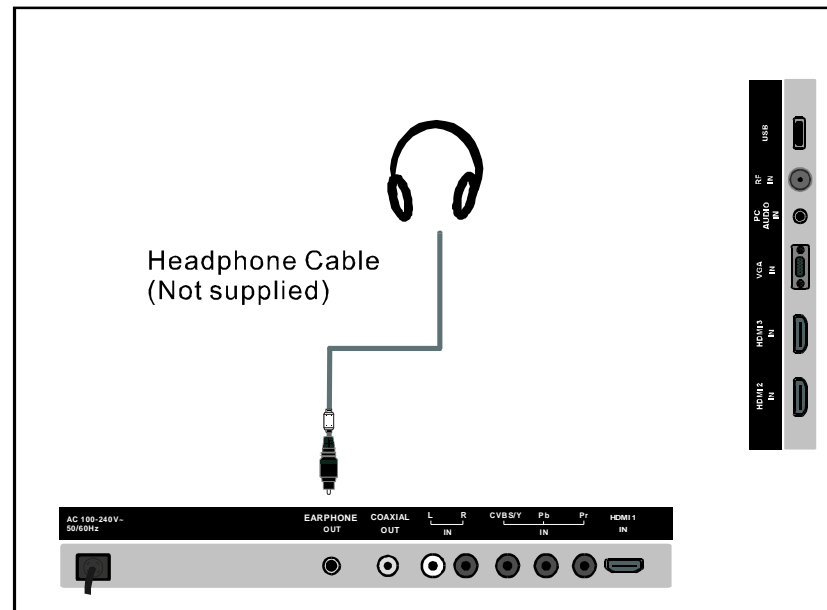

Plug headphone connector into headphone jack on the TV. Then the TV speaker will be muted.

Supporting signals

VGA/PC	Up to 1920×1080@60Hz
Component	480i, 480p, 576i, 576p, 720p, 1080i, 1080p
HDMI	480i, 480p, 576i, 576p, 720p, 1080i, 1080p

Basic Operation

Turning the TV On and Off

How to turn the TV on or off

1. Insert the power cord plug into a polarized AC outlet.
2. Press ϕ button on remote control or POWER button on the LED TV.
3. Normal picture will be displayed on the screen after 6 seconds. If no signal input, "No Signal" will be displayed on the screen.
4. If temporary POWER off is required, press ϕ button on remote control or POWER button on the LED TV.
5. If you want to completely switch off the power for this unit, unplug the power cord plug for this unit.
6. After switching off the unit, you should turn on the TV again at least 5 seconds later.

Status indication lamp

Blue: In power on mode.

Red: In standby mode.

Auto power off

If there is no signal input in TV mode, the TV will automatically access the standby state in about 15 minutes.

Memory before turning TV off

The settings of picture and the preset channels will be memorized at turning off the unit.

When being started up again, the unit will work according to the mode set before being turned off.

OSD Menu Operations

INPUT SOURCE SELECTION

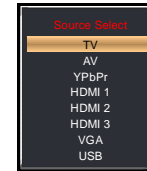

Press SOURCE button to display the input source list;
Press ∇/\blacktriangle button to select the input source you want to watch;
Press ENTER button to enter the input source;

BASIC OPERATION

Press MENU button on the unit or remote control to display the main menu.

Press LEFT or RIGHT navigation button to select Picture/Sound/Time/Setup/Lock/Channel.

Press DOWN navigation button to enter submenu page.

Press UP or DOWN navigation button to select the option that want to adjust.

Press LEFT or RIGHT navigation button to adjust selected option to desired value.

Press RIGHT navigation button or ENTER button to enter next menu page.

Press MENU button to return to previous menu page.

Press EXIT button to exit menu page.



FIRST TIME INSTALLATION

If this is your first time turning on this TV, Setup Wizard will appears on the screen.

Press UP or DOWN navigation button to select wanted item.

Press RIGHT navigation button or ENTER button to enter next menu page.

Press LEFT or RIGHT navigation button to adjust the value.

NOTE:

- In Setup Wizard, the users can adjust Menu Language, Time Zone, Daylight Saving Time and Air / Cable.

- If Air / Cable item has been selected, press UP or DOWN navigation button to select Go to next step in the menu and then press RIGHT navigation button or ENTER button to start auto channel searching.

- Press MENU or EXIT button to exit auto channel searching.



PICTURE

1. Picture Mode

Available options: User, Standard, Dynamic, Soft.

2. Brightness

The value of Brightness can be adjusted from 0-100.

3. Contrast

The value of Contrast can be adjusted from 0-100.

4. Color

The value of Color can be adjusted from 0-100.

5. Tint

The value of Tint can be adjusted from 0-100.

NOTE: Tint is adjustable only in certain TV system.

6. Sharpness

The value of Sharpness can be adjusted from 0-100.

NOTE: The value of Brightness/Contrast/Tint/Sharpness is adjustable only when Picture Mode is User.

7. Color Temperature

Available options: Normal, Warm, Cool.

8. Advanced Settings

Aspect Ratio

Available options: Normal, Wide, Zoom, Cinema.

Noise Reduction

Available options: Off, Low, Medium, High, Auto.

Dynamic Contrast

Available options: On, Off.

HDMI Mode

Available options: Video, Graphic.



SOUND

1. Sound Mode

Available options: Standard, Music, Movie, Sports, User.

2. Bass

The value of Bass can be adjusted from 0-100.

3. Treble

The value of Treble can be adjusted from 0-100.

4. Balance

The value of Balance can be adjusted from -50 to 50.

NOTE: The value of Bass/Treble/Balance is adjustable only when Sound Mode is User.

5. MTS (Multi-channel Television Sound)

This item is used to select preferred sound track.

NOTE: MTS is adjustable only when viewing channels which contain related MTS information.

6. Audio Language

This item is used to select preferred audio language.

7. Digital Audio Output

Available options: Off, PCM, Raw.

8. Surround Sound

Available options: On, Off.

9. AVL (Auto Volume Level)

Available options: On, Off.

10. Speaker

This item is used to turn on/off sound output of your TV speakers.



OSD Menu Operations

TIME

1. Sleep Timer

Available options: Off, 5 Min, 10 Min, 15 Min, 30 Min, 45 Min, 60 Min, 90 Min, 120 Min, 180 Min, 240 Min.

2. Time Zone

Available options: Eastern, Central, Mountain, Pacific, Alaska, Hawaii, Atlantic.

3. Daylight Saving Time

Available options: On, Off.

4. Auto Clock

Available options: On, Off.

5. Clock

- This item is adjustable only when Auto Clock is Off.
- Press LEFT or RIGHT navigation button to move the cursor.
- Press UP or DOWN navigation button to adjust the value.



SETUP

1. Menu Language

This item is used to select preferred OSD menu language.

2. Transparent

This item is used to set transparent level of OSD menu.
Available options: 0%/25%/50%/ 75%/100%.

3. OSD Timeout

Available options: 5/15/30/45/60 seconds

4. Closed Caption

CC Mode

Available options: CC Mute, CC Off, CC On.

Analog CC

Available options: CC1, CC2, CC3, CC4, Text1, Text2, Text3, Text4.

Digital CC

Available options: Service1, Service2, Service3, Service4, Service5, Service6, Off.



OSD Menu Operations

SETUP

Option

This item is adjustable only when Digital CC is not Off.

Mode

Available options: Default, Custom.

Font Style

Available options: Default, Font 0, Font 1, Font 2, Font 3, Font 4, Font 5, Font 6, Font 7.

Font Size

Available options: Default, Normal, Large, Small.

Font Edge Style

Available options: Default, None, Raised, Depressed, Uniform, Left Shadow, Right Shadow.

Font Edge Color

Available options: Default, Black, White, Red, Green, Blue, Yellow, Magenta, Cyan.

FG Color

Available options: Default, White, Red, Green, Blue, Yellow, Magenta, Cyan.

BG Color

Available options: Default, Black, Red, Green, Blue, Yellow, Magenta, Cyan.

FG Opacity

Available options: Default, Solid, Flashing, Translucent, Transparent.

BG Opacity

Available options: Default, Solid, Flashing, Translucent, Transparent.

5. Other Settings

Blue Screen

Available options: On, Off

Audio Only

Available options: On, Off.

NOTE: Once Audio Only function is On, this TV will play the audio only. And press MENU button will resume normal playing.

6. Restore Default

This item is used to reset to factory default settings.

OSD Menu Operations

LOCK

Input the password by pressing number buttons on remote control.

NOTE: The factory default password is 0000.

1. Change Password

- Press RIGHT navigation button or ENTER button to enter it.
- Press number buttons to input the Enter Old Password item.
- Then the screen will display Enter New Password and Confirm Password items.



2. System Lock

Available options: On,Off.

3. Input Block

This item is used to block the input source.

4. US Rating

TV

- Press RIGHT navigation button or ENTER button to enter it.
- Press navigation buttons to move the cursor.
- Press ENTER button to block or unblock it.

MPAA

Available options: Off, G, PG, PG-13, R, NC-17, X.

5. Canada Rating

Canada English

Available options: Off, C, C8+, G, PG, 14+, 18+.

Canada French

Available options: Off, G, 8 ans+, 13 ans+, 16 ans+, 18 ans+.

NOTE: Input Block, US Rating and Canada Rating items are adjustable only when System Lock is On.

6. RRT Rating

This item is available only when viewing channels which contain related Advance Rating information.

7. Reset RRT

This item is used to reset RRT Rating.

OSD Menu Operations

CHANNEL

1. Air/Cable

This item is used to select preferred signal receiving Type.



2. Auto Scan

- Press RIGHT or ENTER button to enter it.
- Then a dialog box will appear on the screen. Select No to return to upper menu page, and select Yes to start auto channel searching.
- Press MENU or EXIT button to exit auto channel searching.

3. Favorite

- Press RIGHT or ENTER button to enter it.
- Press UP or DOWN navigation button to select preferred channel.
- Press ENTER button to label the selected channel as a favorite one or not.

4. Channel List

- Press RIGHT or ENTER button to enter it.
- Press UP or DOWN navigation button to select preferred channel.
- Press ENTER button to enter the selected channel directly.

5. Show/Hide

- Press RIGHT or ENTER button to enter it.
- Press UP or DOWN navigation button to select preferred channel.
- Press ENTER button to show or hide the selected channel.

6. Channel Number

- Press LEFT or RIGHT navigation button to select preferred channel number.

7. Channel Label

- Press RIGHT or ENTER button to enter it.
- Press LEFT or RIGHT navigation button to move the cursor.
- Press UP or DOWN navigation button to adjust the value.



OSD Menu Operations

PC SETTINGS

Press SOURCE button on the unit or remote control to set the unit in VGA mode.
Press MENU button to display the main menu and select Setup item. Then press DOWN navigation button to enter Setup menu page.

Press UP or DOWN navigation button to select PC Settings and press RIGHT navigation button or ENTER button to enter it.

1. H-Pos (Horizontal Position)

Available range: 0-100.

2. V-Pos (Vertical Position)

Available range: 0-100.

3. Clock

Available range: 0-100.

4. Phase

Available range: 0-100.

5. Auto

If this item is entered, it will adjust the PC screen automatically.



USB

USB Operation

Before following operations, insert a USB memory device first, which contains Photo and Music files.

Press SOURCE button on unit top or remote control to set the unit in Media mode.



USB

USB Operation

Photo Playback

Select photo item in the main menu and press ENTER button to enter it.

Then press ENTER button to enter disc C.

Press navigation buttons to select which photo to be played, and then press ENTER button to playback the selected photo.



Press LEFT or RIGHT navigation buttons to select wanted option, and then press enter button to confirm it.

Press EXIT button to hide tool bar, and then press ENTER button to display tool bar again.

Press EXIT button to return to previous menu page.

Music Playback

Select music item in the main menu and press ENTER button to enter it.

Then press ENTER button to enter disc C.

Press navigation buttons to select which song to be played, and then press ENTER button to playback the selected music file.



Press LEFT or RIGHT navigation buttons to select wanted option, and then press enter button to confirm it.

Press EXIT button to return to previous menu page.

Troubleshooting

If you have any problem, check the countermeasures for each symptom listed below. The following symptoms may have caused by inappropriate adjustment rather than actual malfunction of the unit. If the trouble persists, contact the service center.

Symptoms	Possible solutions
No power	Please check the power cord is plugged in. Unplug the power cord and plug it after 60 seconds and restart the TV.
No picture	Please check antenna connection. Station may experience problems, please tune to another station. Please adjust the settings of contrast and brightness.
Good picture but no sound	Please increase the volume. Please check TV is under mute mode, press MUTE button on the remote control. Please check sound settings.
Good sound but abnormal color or no picture	Please check the antenna connection.
No remote control	Batteries of remote control may have been exhausted, if necessary, please change the batteries. Clean the remote control lens. The distance between LED TV and remote control should be within 8m.
Full screen flickering under VGA	V-HEIGHT value may be set too big, restart computer and enter safe mode, then set monitor parameters to correct value according to adjustment description.
Horizontal stripes under VGA	Sample phase may be deflected, adjust phase according to picture position.
Colored dots may be present on the screen	This product is the high resolution LED display device and a few cell defects can occur in the manufacture of the LED. Several colored dots visible on the screen would be acceptable. in line with other LED manufacturers and would not mean that the LED is faulty. We hope you will understand that it could not be changed or refunded.

Picture defects and the reason



Snowy Picture

Snowy picture is usually due to weak signal. Adjust antenna or install an antenna amplifier.



Double Image or Ghosts

Double images are usually caused by reflections from tall buildings. Adjust the direction of the antenna or raise it.



Radio Wave Interference

Wave patterns are moving on the screen, which are usually caused by nearby radio transmitters or short-wave receiving equipment.



High Temperature Electrothermal Interference

Diagonal or herringbone patterns appear on the screen or part of picture is missing. This is probably caused by high temperature electrothermal equipment in a nearby hospital.